



BX14

Discontinuous Totalizer and Extraction Scale Controller

User and Technical Manual

Contents:

1.	Safety Instructions	4
2.	Introduction	6
2.1	Overview	6
2.2	Key features and specifications	6
3.	The Front View and Key Functions	10
3.1	Display	10
3.3	Key Pad	11
3.4	Housing	11
3.6	Accessories	14
3.6.1	Accessories supplied with the instrument	14
3.6.2	Accessories sold separately	14
4.	Installation	15
4.1	Recommendations	15
4.1.1	Control Cabinet Design	15
4.1.2	Cabling	15
4.2	Mechanical Installation	15
4.3	Electrical Connections	15
4.3.1	Power Supply Connection and Grounding	16
4.3.2	Load Cell Connection	17
4.3.3	RS 232C Connection	17
4.3.4	RS 485 and Modbus-RTU Connection	18
4.3.5	Profibus Connection (only BX14 PB)	18
4.3.6	Profinet Connection (only BX14 PN)	19
4.3.7	Ethernet Connection (only BX14 EN)	20
4.3.8	CANopen Connection (only BX14 CO)	21
4.3.9	EtherNet/IP Connection (only BX11 EI)	22
4.3.10	EtherCAT Connection (only BX14 EC)	23
4.3.11	CC-Link Connection (only BX14 CC)	24
4.3.12	Powerlink Connection (only BX14 PL)	25
4.3.14	Digital Inputs and Outputs Connection	26
4.4	Commissioning	28
5.	Serial Data Outputs	29
5.1	Continuous Data Output	29
5.2	Fast Continuous Data Output	30
5.3	Print Mode	30
5.4	BSI Data Structure	31
6.	Filling Target and Preset Values' Entry	38
7.	Operation	39
8.	Programming and Calibration	44
8.1	Entering the Programming and Calibration	44
8.2	Fast Access to the Calibration	45
8.3	Exiting the Programming and Calibration	45
8.5	Programming	47

9.	Modbus RTU	62
9.1	Modbus RTU Data Structure	62
10.	Profibus (only BX14 PB)	69
10.1	Data Format	70
10.2	GSD Configuration	70
10.3	Profibus DP Data Structure	71
11.	Profinet (only BX14 PN)	78
11.1	Data Format	79
11.2	Profinet Parameters	79
11.3	GSDML Configuration	80
11.4	Profinet Data Structure	81
12.	Ethernet TCP/IP (only BX14 EN)	88
12.1	Ethernet Setup	88
12.2	Modbus TCP Data Structure	90
13.	CANopen (only BX14 CO)	96
13.1	Data Format	97
13.2	EDS Configuration	97
13.3	CANopen Data Structure	98
14.	EtherNet/IP (only BX14 EI)	105
14.1	Data Format	106
14.2	EtherNet/IP Parameters	106
14.3	EDS Configuration	107
14.4	EtherNet/IP Data Structure	109
15.	EtherCAT (only BX14 EC)	116
15.1	Data Format	117
15.2	ESI Configuration	117
15.3	EtherCAT Data Structure	118
16.	CC-Link (only BX14 CC)	125
16.1	Data Format	125
16.2	CC-Link Configuration	125
16.4	CC-Link Data Structure	127
17.	Powerlink (only BX14 PL)	134
17.1	Data Format	135
17.2	XDD Configuration	135
17.3	Powerlink Data Structure	136
18.	Approved Scale's Sealing	143
19.	Trouble Shooting	144
20.	Parameter's Default Table	145
21.	Calibration Table	146
22.	Frequently Asked Questions	147

RIGHTS AND LIABILITIES

All rights reserved.

No part of this publication may be reproduced, stored in a retrieval system, or transmitted in any form or by any means, mechanical, photocopying, recording, or otherwise, without the prior written permission of BAYKON A.S.

No patent liability is assumed with respect to the use of the information contained herein. While every precaution has been taken in the preparation of this book, BAYKON assumes no responsibility for errors or omissions. Neither is any liability assumed for damages resulting from the use of the information contained herein.

The information herein is believed to be both accurate and reliable. BAYKON, however, would be obliged to be informed if any errors occur. BAYKON cannot accept any liability for direct or indirect damages resulting from the use of this manual.

BAYKON reserves the right to revise this manual and alter its content without notification at any time.

Neither BAYKON nor its affiliates shall be liable to the purchaser of this product or third parties for damages, losses, costs, or expenses incurred by purchaser or third parties as a result of: accident, misuse, or abuse of this product or unauthorized modifications, repairs, or alterations to this product, or failure to strictly comply with BAYKON operating and maintenance instructions.

BAYKON shall not be liable against any damages or problems arising from the use of any options or any consumable products other than those designated as Original BAYKON Products.

NOTICE: The contents of this manual are subject to change without notice.

Copyright © 2012 by BAYKON A.S. Istanbul, Turkey

1. SAFETY INSTRUCTIONS



CAUTION! READ THIS MANUAL BEFORE OPERATING OR SERVICING THIS EQUIPMENT. FOLLOW THESE INSTRUCTIONS CAREFULLY. SAVE THIS MANUAL FOR FUTURE REFERENCE. DO NOT ALLOW UNTRAINED PERSONNEL TO OPERATE, CLEAN, INSPECT, MAINTAIN, SERVICE, OR TAMPER WITH THIS EQUIPMENT. ALWAYS DISCONNECT THIS EQUIPMENT FROM THE POWER SOURCE BEFORE CLEANING OR PERFORMING MAINTENANCE. CALL BAYKON ENGINEERING FOR PARTS, INFORMATION, AND SERVICE.



WARNING! ONLY PERMIT QUALIFIED PERSONNEL TO SERVICE THIS EQUIPMENT. EXERCISE CARE WHEN MAKING CHECKS, TESTS AND ADJUSTMENTS THAT MUST BE MADE WITH POWER ON. FAILING TO OBSERVE THESE PRECAUTIONS CAN RESULT IN BODILY HARM.



WARNING! FOR CONTINUED PROTECTION AGAINST SHOCK HAZARD CONNECT TO PROPERLY GROUNDED OUTLET ONLY. DO NOT REMOVE THE GROUND PRONG.



WARNING! DISCONNECT ALL POWER TO THIS UNIT BEFORE REMOVING ANY CONNECTION, OPENING THE ENCLOSURE OR SERVICING.



WARNING! BEFORE CONNECTING/DISCONNECTING ANY INTERNAL ELECTRONIC COMPONENTS OR INTERCONNECTING WIRING BETWEEN ELECTRONIC EQUIPMENT ALWAYS REMOVE POWER AND WAIT AT LEAST THIRTY (30) SECONDS BEFORE ANY CONNECTIONS OR DISCONNECTIONS ARE MADE. FAILURE TO OBSERVE THESE PRECAUTIONS COULD RESULT IN DAMAGE TO OR DESTRUCTION OF THE EQUIPMENT OR BODILY HARM.



CAUTION! OBSERVE PRECAUTIONS FOR HANDLING ELECTROSTATIC SENSITIVE DEVICES.

BAYKON ENDÜSTRİYEL KONTROL SİSTEMLERİ SAN. VE TİC. A.Ş.



Kimya Sanayicileri Organize Sanayi Bölgesi Organik Cad. No:31
34956 Tepeören Tuzla/İSTANBUL TURKEY

This declaration of conformity is issued under sole responsibility of the manufacturer.

Bu uygunluk beyanı imalatçının sorumluluğu altında düzenlenmiştir.

The object of the declaration described above is in conformity with the relevant Union harmonisation legislation:

Yukarıda belirtilen beyan konusu, ilgili şu AB mevzuatına uygundur:

EU Directive: AB Yönetmelikleri:	Applicable Standards: Uygulanabilir Standartlar:
Low Voltage Directive (LVD): (2014/35/EU) Alçak Gerilim Yönetmeliği (LVD): (2014/35/AB)	EN 60950-1:2008 / TS EN 60950-1:2008
Electromagnetic Compatibility (EMC): (2014/30/EU) Elektromanyetik Uyumluluk Yönetmeliği (EMC): (2014/30/AB)	EN 61326-1:2013 / TS EN 61326-1:2013
Measuring Instruments Directive: (2004/22/EU) Ölçüm Aletleri Yönetmeliği: (2004/22/AB)	OIML R107
RoHS Directive: (2011/65/EU) RoHS Yönetmeliği	EN 50581:2012 / TS EN 50581:2013
Non-Automatic Weighing Instrument Directive: (2014/31/EU) Otomatik Olmayan Tartı Aletleri Yönetmeliği: (2014/31/AB)	EN 45501:1992 / TS EN 45501:1997
Type/Tip	BX14...
EU Type Examination AB Tip İncelemesi	NAWI DK 0199.452 MID DK 0199.497
   YY = The last two digits of the year. / Yılın son iki rakamı. XXXX = The notified body number. / Onaylanmış kuruluş numarası.	

Notified Body no.0199 DELTA Danish Electronics, Light&Acoustics performed EU-type examination and issued the certificate.

AB Tip İncelemesi çalışmalarını Onaylanmış Kuruluş no.0199 DELTA Danish Electronics, Light&Acoustics yürüterek sertifikayı düzenlemiştir.

The manufacturer's Quality System accordant with module D is under the supervision of Notified Body no. 1259 METAS-Cert. Related certificate can be reached in below address.

Üreticinin Modül D Kalite Sistemi uygunluğu Onaylanmış Kuruluş no. 1259 METAS-Cert gözetimi altındadır. İlgili sertifikaya aşağıdaki adresten ulaşılabilir.

www.metas.ch/certsearch

Baykon, July 2016

Temmuz 2016

Quality Assurance Manager

Kalite Güvence Müdürü

Important notice for verified weighing instruments in EU countries;

AB ülkelerinde doğrulanan tartı aletleri için önemli not;



Verifiable filling instruments at the place of usage bear the preceding mark on the packing label. Verification must be carried out by the Baykon or by another authorities firm for legal instruments. Please contact to Baykon.

Kullanım yerinde doğrulanabilir dolum aletleri, ambalajında yandaki işareti taşırlar. Yasal aletler için Doğrulama Baykon veya başka yetkili kuruluş tarafından yapılmalıdır. Lütfen Baykon'la bağlantıya geçiniz.

If national regulations in individual countries limit the period of validity of the certification, the operator of such a scale is himself responsible for its timely re-certification.

Tartı aletinin kullanıldığı ülkelerde ulusal hükümler sertifikanın geçerlilik periyodunu sınırlıyorsa, sertifikanın yenilenmesi dolum aletinin kullanıcısının sorumluluğundadır.

2. INTRODUCTION

2.1 Overview

BX14 discontinuous totalizer is used for flow control on the production line together with totalizing the transferred material. This instrument also gives information estimated next 24h total for the actual flow rate and daily total. Additional 3 accumulations can be used for different purposes like production batch total, turn total, weekly total etc. This controller has 4 opto-isolated digital input, 2 non-isolated digital input and 5 relay contact outputs.

2.2 Key features and specifications

Features:

	BX14	BX14 PB	BX14 PN	BX14 EN	BX14 CO	BX14 EI	BX14 EC	BX14 CC	BX14 PL
1 000 to 999 999 display resolution	Yes	Yes	Yes	Yes	Yes	Yes	Yes	Yes	Yes
High internal resolution up to 16 000 000 counts	Yes	Yes	Yes	Yes	Yes	Yes	Yes	Yes	Yes
Up to 1600 conversion per second	Yes	Yes	Yes	Yes	Yes	Yes	Yes	Yes	Yes
Serial interface RS 232C	Yes	Yes	Yes	Yes	Yes	Yes	Yes	Yes	Yes
Serial interface RS 485	Yes	Yes	Yes	Yes	Yes	Yes	Yes	Yes	Yes
Modbus RTU	Yes	Yes	Yes	Yes	Yes	Yes	Yes	Yes	Yes
Modbus TCP	-	-	-	Yes	-	-	-	-	-
Profibus DPV1 interface	-	Yes	-	-	-	-	-	-	-
Profinet interface	-	-	Yes	-	-	-	-	-	-
Ethernet interface	-	-	-	Yes	-	-	-	-	-
CANopen interface	-	-	-	-	Yes	-	-	-	-
EtherNet/IP interface	-	-	-	-	-	Yes	-	-	-
EtherCAT interface	-	-	-	-	-	-	Yes	-	-
CC-Link interface	-	-	-	-	-	-	-	Yes	-
Powerlink interface	-	-	-	-	-	-	-	-	Yes
Continuous data output	Yes	Yes	Yes	Yes	Yes	Yes	Yes	Yes	Yes
Fast Continuous data output	Yes	Yes	Yes	Yes	Yes	Yes	Yes	Yes	Yes
BSI data interface	Yes	Yes	Yes	Yes	Yes	Yes	Yes	Yes	Yes
4 digital input and 5 relay contact output	Yes	Yes	Yes	Yes	Yes	Yes	Yes	Yes	Yes
2 non- isolated inputs	Yes	Yes	Yes	Yes	Yes	Yes	Yes	Yes	Yes
Auto-zero tracking	Yes	Yes	Yes	Yes	Yes	Yes	Yes	Yes	Yes
Motion detection	Yes	Yes	Yes	Yes	Yes	Yes	Yes	Yes	Yes
Zeroing and Taring by field bus command	Yes	Yes	Yes	Yes	Yes	Yes	Yes	Yes	Yes
Adaptive digital filter for fast and stable reading	Yes	Yes	Yes	Yes	Yes	Yes	Yes	Yes	Yes
Electronic calibration (eCal) without test weights	Yes	Yes	Yes	Yes	Yes	Yes	Yes	Yes	Yes
Electronic calibration (eCal) over field bus	Yes	Yes	Yes	Yes	Yes	Yes	Yes	Yes	Yes
Zero and Span calibrations over field bus	Yes	Yes	Yes	Yes	Yes	Yes	Yes	Yes	Yes
Zero adjustment	Yes	Yes	Yes	Yes	Yes	Yes	Yes	Yes	Yes
Span adjustment with test weights	Yes	Yes	Yes	Yes	Yes	Yes	Yes	Yes	Yes
Span adjustment for filled tanks	Yes	Yes	Yes	Yes	Yes	Yes	Yes	Yes	Yes
3 point calibration (linearity correction)	Yes	Yes	Yes	Yes	Yes	Yes	Yes	Yes	Yes
Programming by BAYKON IndFace1X PC software	Yes	Yes	Yes	Yes	Yes	Yes	Yes	Yes	Yes
8 load cells 350 Ω or 18 load cells 1100 Ω	Yes	Yes	Yes	Yes	Yes	Yes	Yes	Yes	Yes
12 to 28 VDC power supply range	Yes	Yes	Yes	Yes	Yes	Yes	Yes	Yes	Yes

Specifications:

Common Specifications		
A/D Converter:		
A/D converter type:	24 bit Delta-Sigma ratiometric with integral analog and digital filters	
Conversion rate:	Up to 1600 measurement values per second	
Input sensitivity:	0.4 $\mu\text{V/d}$ (Approved); 0.1 $\mu\text{V/d}$ (Non approved)	
Analog input range:	- 18 mV to +18 mV	
Internal resolution:	up to 16 000 000	
External Resolution:		
Display resolution	up to 10 000 increment (Approved); up to 999 999 increment (Non approved)	
Scale Calibration and Functions:		
Calibration:	Calibration is performed with or without test weights (eCal)	
Digital filter:	10 steps programmable adaptive filter	
Weighing functions:	Zeroing, auto zero tracking, motion detection, increased resolution.	
Application functions:	Flow rate control, Accumulation control, By-pass function, control of emptying pipe, ton/hour, 4 pcs accumulation, estimated 24h total indications,	
Linearity:		
	Within 0.0015% FS, $\leq 2 \text{ ppm}/^\circ\text{C}$	
Load cells:		
Excitation:	5 VDC max. 125 mA	
Number of load cells:	Up to 8 load cells 350 Ω or 25 load cells 1100 Ω in parallel	
Connection:	4- or 6-wire technique. Cable length: maximum 1000 m/mm ² for 6-wire connection	
Communication:		
Data Formats	Continuous, Fast Continuous, Printer formats, BSI Protocol, Modbus RTU	
RS 232C	Baudrate	1200 to 115200 baudrate, 8N1 / 7O1 / 7E1 / 8O1 / 8E1
	Response speed:	Up to 4 ms response delay after read/write commands
RS 485	Baudrate	1200 to 115200 baudrate, 8N1 / 7O1 / 7E1 / 8O1 / 8E1
	Response speed:	Up to 4 ms response delay after read/write commands
	Max Stations:	Up to 31 stations per segment
Digital Inputs and Outputs:		
Digital Inputs	4 opto-isolated and 2 non-isolated digital inputs 12 to 28 VDC, 10mA	
Digital Outputs	5 free relay contact 250 VAC or 30 VDC , 1A	
Non-isolated inputs	2 non- isolated inputs for By-Pass and Emptying pipe control	
DC Power supply:		
	12 to 28 VDC max. 300 mA	
Environment and Enclosure:		
Operation temp.:	-15 $^\circ\text{C}$ to +55 $^\circ\text{C}$; 85% RH max, non-condensing	
Enclosure	Panel type, front panel and rear panel are stainless steel; Aluminum body.	
Protection	Front panel IP65	

BX14 PB Profibus DPV1	
Communication:	
Data rate:	Up to 12000 kbit/s with automatic baud rate detection
GSD file	Generic GSD-file provided
Topology:	Depending on physical media RS-485: segmented line topology without stubs
Installations:	Shielded twisted pair cable Line length depending on physical media and transmission speed
Max. Stations:	Up to 32 stations per segment, up to 125 stations per network
Isolation:	Galvanically isolated bus electronics
Response speed:	Up to 4 ms response delay after read/write commands

BX14 PN Profinet	
Communication:	
Data rate:	100 Mbit/s, full duplex
GSDML file:	Generic GSDML-file provided
TCP/IP settings:	DHCP or manual IP assign over EtherX PC Software. Device identity customization
Topology:	Line, Bus, Star or Tree topology depending on physical media
Installation:	Switched Ethernet transmission with shielded twisted pair cables and RJ-45 connectors.
Isolation:	Galvanically isolated bus electronics
Response speed:	Up to 4 ms response delay after read/write commands

BX14 EN Ethernet TCP	
Communication:	
Transmission rate:	10 Mbit/s, half duplex
TCP/IP settings:	Manual IP assign over EtherX PC Software or by keys in programming mode.
Installation:	Switched Ethernet transmission with shielded twisted pair cables and RJ-45 connectors.
Web client:	Available
Response speed:	Up to 4 ms response delay after read/write commands

BX14 CO CANopen	
Communication:	
Data rate:	10 kbit/s – 1 Mbit/s (selectable) kbit/s
EDS file	Generic EDS-file provided
Topology:	Line with Trunkline, Dropline structure and Termination at both Ends Line length depending on baudrate 25 – 500 meter.
Installation:	2 wire shielded twisted pair cable Alternatively 4 wire with 24 Volt power over the bus
Max. Stations:	Up to 127 stations per network
Isolation	Galvanically isolated bus electronics
Response speed:	Up to 4 ms response delay after read/write commands

BX14 EI EtherNet/IP	
Communication	
Data rate	10 Mbit/s or 100 Mbit/s, full duplex
EDS file	Generic EDS-file provided
DLR (Device Level Ring)	Available
TCP/IP settings	DHCP or manual IP assign over EtherX PC Software. Device identity customization
Topology	Line, Bus, Star or Tree topology depending on physical media
Installation	Switched Ethernet transmission with shielded twisted pair cables and RJ-45 connectors.
Web client	Available
Isolation	Galvanically isolated bus electronics
Response speed	Up to 4 ms. response delay after read/write commands.

BX14 EC EtherCAT	
Communication	
Data rate	100 Mbit/s, full duplex
ESI file	Generic ESI-file provided
Topology	Line, Tree, Star or Daisy-chain topology depending on physical media
Installation	Switched Ethernet transmission with shielded twisted pair cables and RJ-45 connectors.
Isolation	Galvanically isolated bus electronics
Response speed	Up to 4 ms. response delay after read/write commands.

BX14 CC CC-Link	
Communication	
Data rate	156 kbit/s – 10 Mbit/s (selectable)
Topology	Line with Trunkline, Branch structure and Termination at both Ends.
Installation	3 wires shielded twisted pair cable.
Max. Stations	Up to 64 stations per network
Isolation	Galvanically isolated bus electronics
Response speed	Up to 4 ms. response delay after read/write commands

BX14 PL Powerlink	
Communication	
Data rate	100 Mbit/s, half duplex
Compatibility	Supports POWERLINK V2.0 Communication Profile Specification version 1.2.0
XDD file	XDD-file provided
Ring redundancy	Available
Topology	100% free choice of star, tree, ring or daisy chain
Installation	Switched Ethernet transmission with shielded twisted pair cables and RJ-45 connectors.
Isolation	Galvanically isolated bus electronics
Response speed	Up to 4 ms. response delay after read/write commands

3. THE FRONT VIEW AND KEY FUNCTIONS



Figure 3-1 - Front panel view of BX14

3.1 Display

The weight display of BX14 is 14mm height 6 digit LED. Annunciators below are located at the left and right side of the weight display.

The meanings of the announcement LED's on the display are:

1/h	Announces the flow rate together with the unit on the right of the display. For example: if this symbol seems together with t unit, the displayed flow rate unit is t/h.
→0←	Announces the weight is in the center of zero.
~	Announces the weight value on the display is unstable.
24h	Announces the calculated next 24h material transfer for the actual flow rate.
Σ	Total material weight accumulation.
Unit	Kilogram (kg), libre (lb) and ton (t) units are located on the right of the display.

3.3 Key Pad

The keys and the key functions of BX14 are:



Function : Flow rate, Estimated daily total and total values are displayed sequentially by pressing this key (*Page 39*).



Target/Coarse/Fine Menu : Pressing this key for entering target (nominal filling value), Coarse lead in and fine lead in values (*Page 38*).

Application Related Parameters : To enter the process parameter menu, long press this key. Refer to related mode (*Page 39*).



Tare / Clear : Pressing this key tares the scale and get into the Net mode in weighing mode.



Zeroing: In Gross mode and Ready state, if the scale doesn't show zero while there is no load on the hopper, you can zero the scale by pressing this key.



Print: By pressing this key weight data and other information depending on the setup parameters sent to a printer or a PC via serial port in basic weighing mode.

3.4 Housing

BX14 housings are panel type with stainless steel front and back parts and aluminum body.

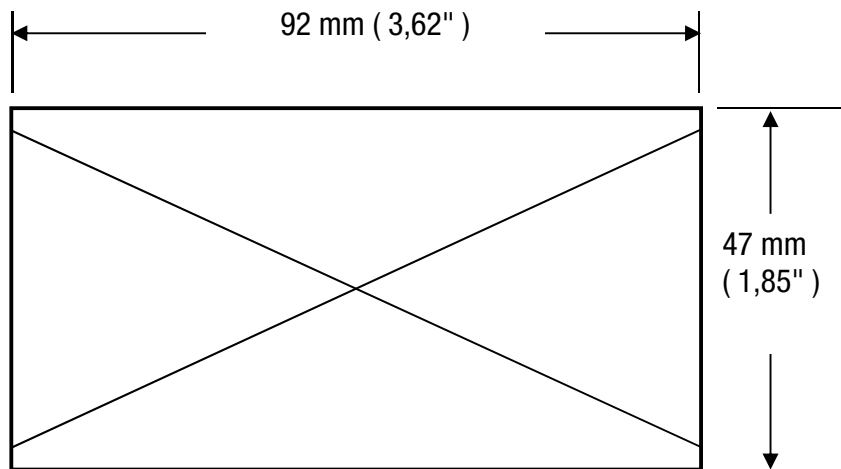

The hole dimensions for mounting BX14 on the panel

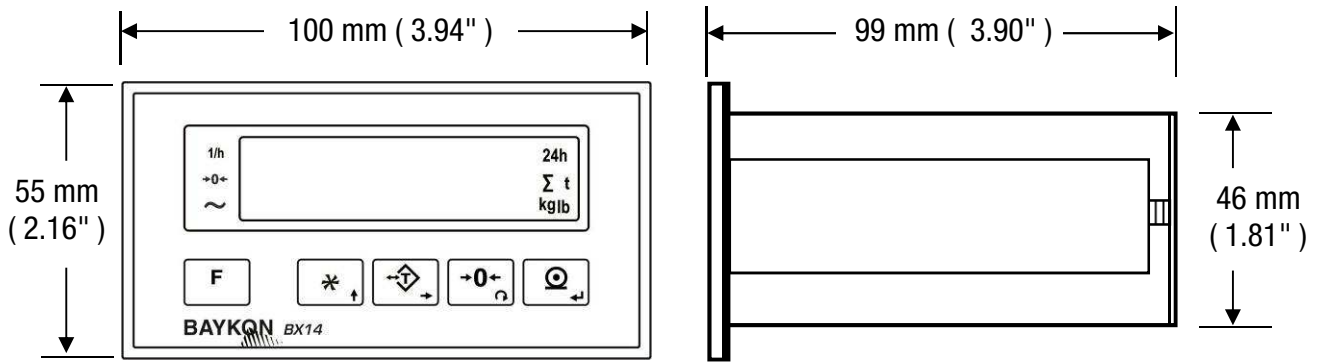

BX14 front and side view

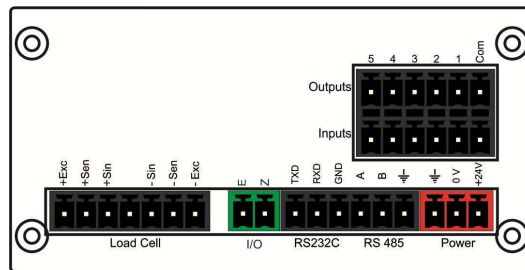

BX14 Panel type rear view

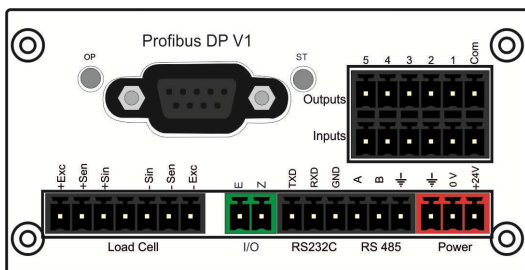

BX14 PB Panel type rear view

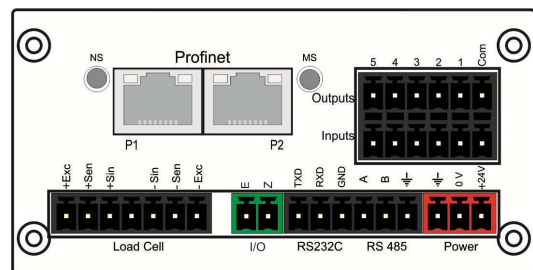

BX14 PN Panel type rear view

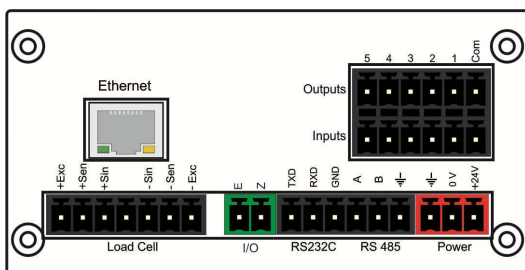

BX14 EN Panel type rear view

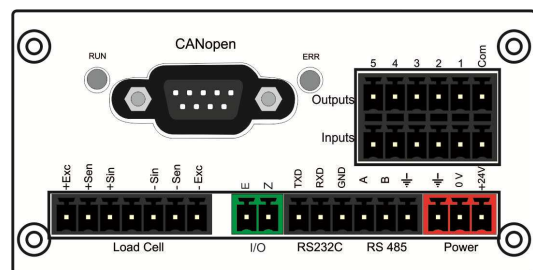

BX14 C0 Panel type rear view

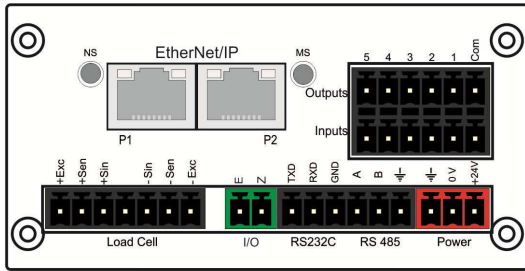

BX14 EI Panel type rear view

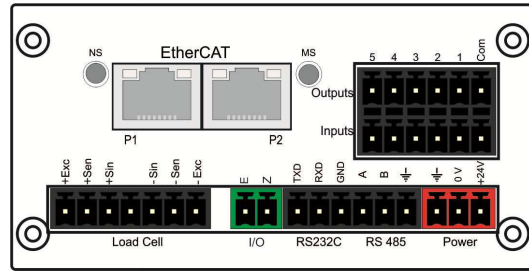

BX14 EC Panel type rear view

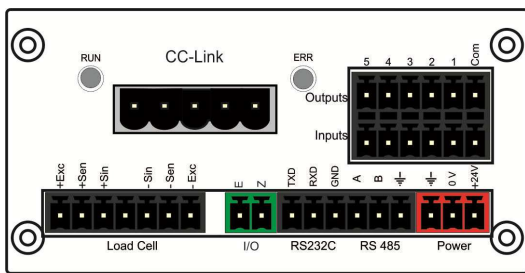

BX14 CC Panel type rear view

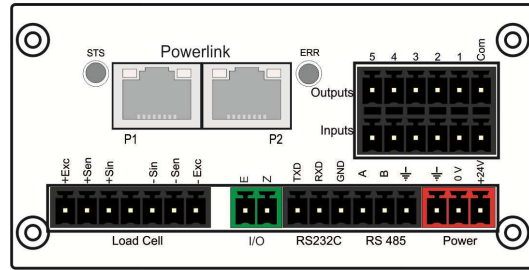

BX14 PL Panel type rear view

3.6 Accessories

The following accessories are supplied with the instrument or can be purchased separately.

3.6.1 Accessories supplied with the instrument

The following accessories are supplied together with the BX14 instruments. If any part is missed, please contact to your supplier.

	BX14	BX14 PB	BX14 PN	BX14 EN	BX14 CO	BX14 EI	BX14 EC	BX14 CC	BX14 PL
3-pos and 3,81 mm pitch red plug for power supply	1	1	1	1	1	1	1	1	1
7-pos and 3,81 mm pitch black plug for load cell cable	1	1	1	1	1	1	1	1	1
6-pos and 3,81 mm pitch black plug for RS232C & RS485	1	1	1	1	1	1	1	1	1
6-pos and 3,81 mm pitch black plug for I/O	2	2	2	2	2	2	2	2	2
2-pos and 3,81 mm pitch green plug for non-isolated inputs	1	1	1	1	1	1	1	1	1
Installation CD (IndFace1X setup, Manual and technical documents)	1	1	1	1	1	1	1	1	1

Table 3-1 - Accessories supplied with instrument

3.6.2 Accessories sold separately

The following accessories can be supplied from BAYKON.

	BX14	BX14 PB	BX14 PN	BX14 EN	BX14 CO	BX14 EI	BX14 EC	BX14 CC	BX14 PL
Sealing kit for approved scales	√	√	√	√	√	√	√	√	√
RS-232C cable for PC connection (3 meter)	√	√	√	√	√	√	√	√	√
Junction box for load cell connection	Refer to junction box catalog								
Open end load cell cable 6 wire (0.22 cm ² each)	Maximum 200 meter length								

Table 3-2 - Accessories supplied separately

4. INSTALLATION

PRECAUTION: Please read this section carefully before installation of the instrument. Applying the recommendations in this section will increase your system reliability and long term performance.

4.1 Recommendations

4.1.1 Control Cabinet Design

Warning: Please care the following warnings for designing the control cabinet which will increase your system reliability.

The control cabinet should be designed so that Analog Digitizer can operate safely. The panel should be placed clean area, not getting direct sun light if possible, with a temperature between -15 °C and +55 °C, humidity not exceeding 85% non-condensing. All external cables should be installed safely to avoid mechanical damages.

BX14 instruments are very low level signal measuring instruments. To avoid electrical noise, BX14 should be separated from the equipments that produce electrical noise. Preferable use metal cabinet against radio frequency interference and the cabinet shall be connected to ground against the electromagnetic disturbances. Load cell cable trays must be separated from others, if possible. If there are noise-generating equipments such as heavy load switches, motor control equipments, inductive loads etc., please be careful against the EMC interference in the cabinet. If possible protect BX14 instruments with the faraday cage or install them in separate section or install them far a way from this kind of equipments. Connect parallel reverse diodes to the DC inductive loads like relays, solenoids etc. to minimize voltage peaks on the DC power lines.

4.1.2 Cabling

All cables coming to the control cabinet shall be shielded. Please use separate cable tray for these low signal level cables. Distance from load cell cables, interface cables and DC power supply cables to power line cables shall be minimum 50 cm.

4.2 Mechanical Installation

Take care to the housing dimensions and the suggested panel hole dimensions given in the *Page 11*. To avoid electrical noises, protect your controller which has very low input signal level from the equipment that produces electrical noise in panel mounting.

4.3 Electrical Connections

Warning: Please always remember that BX14 instruments are very low voltage measuring instruments. Your control cabinet design and proper installation increases reliability and performance of the instrument. Please do not forget that the instrument must be powered off before inserting or removing any peripheral connector.

The electrical installation and quality of instrument's grounding will provide weighing accuracy and the safety of your controller. If the energy condition of your plant is bad, prepare a special power line and grounding. All required electrical connections should be done as described below.

If you have to service the controller, turn the power off and wait at least 30 seconds before interfering.

If any, a set-up DIP switch on BX14's rear side and its position should be "ON" (downward) to change the metrological related parameters including calibration. If there is not set-up DIP switch on the instrument for industrial usage, its position is ON as a default. There is no need to open the housing to change the position of this DIP switch.

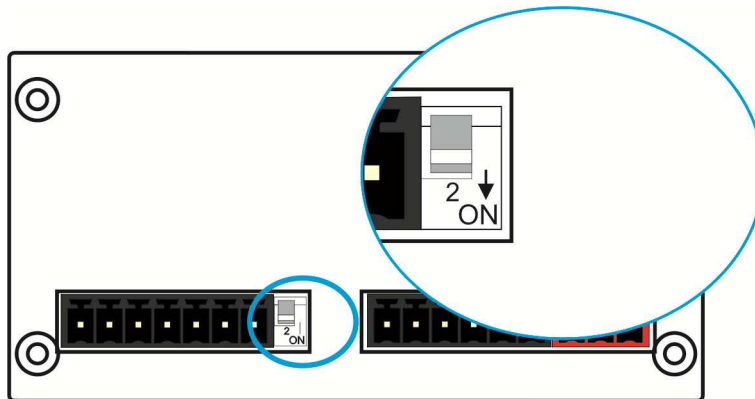

Figure 4-1 - The location of calibration DIP switch

4.3.1 Power Supply Connection and Grounding

Power supply voltage of the instrument shall be between 12 VDC and 28 VDC. The pin configuration of the 24 VDC power supply connector located right - bottom of the instrument is shown in Figure 4-2 below.

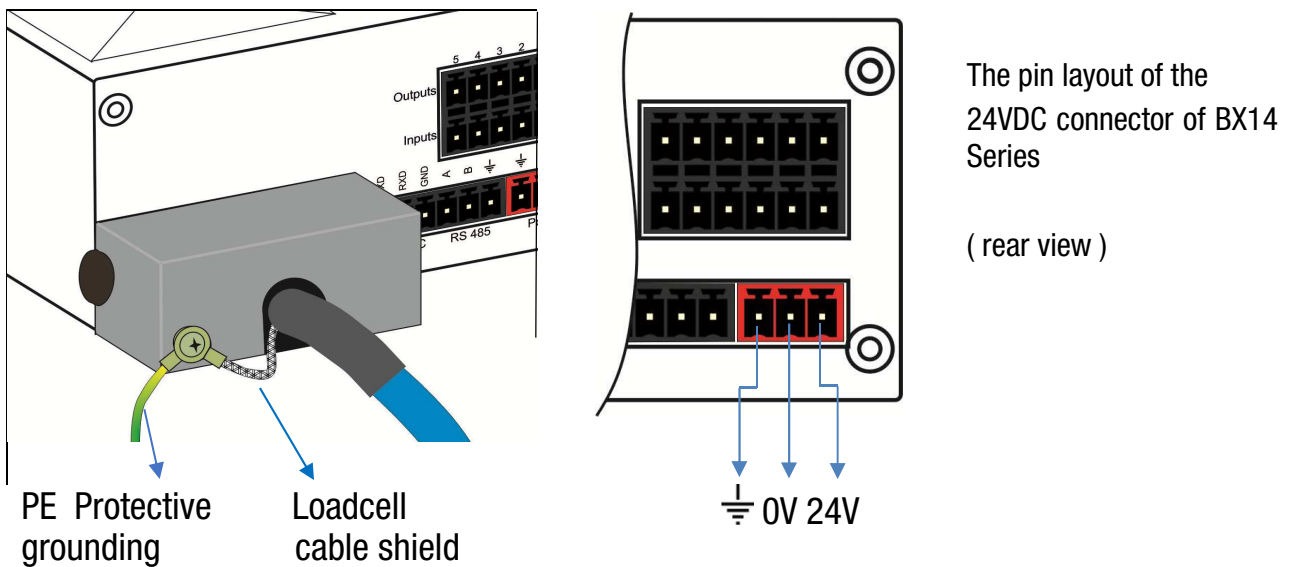

Figure 4-2 - The pin layout of 24VDC connector

The quality of the instrument's ground will determine the accuracy and the safety of your measuring system. A proper ground connection is needed to minimize extraneous electrical noise effects on the measurement. A poor ground can result in an unsafe and unstable operation. It is important that the instrument should not share power lines with noise-generating parts such as heavy load switching relays, motor control equipments, inductive loads, etc. If the condition of the power line in the plant is poor, prepare a special power line and grounding.

Before interfering the instrument, turn off the power and wait at least for 30 seconds.

Warning: Connect the Shield pin to the reference ground.

4.3.2 Load Cell Connection

To avoid damages, the load cell wiring should be made carefully before energizing the instrument. Load cell connection detail is shown in Figure 4-3. In 4-wire installations the sense and excitation pins with the same polarity **should be short circuited** at the connector side. If you have junction box, use 6 wire cable between BX14 and the junction box, and short circuit these pins at junction box for better performance.

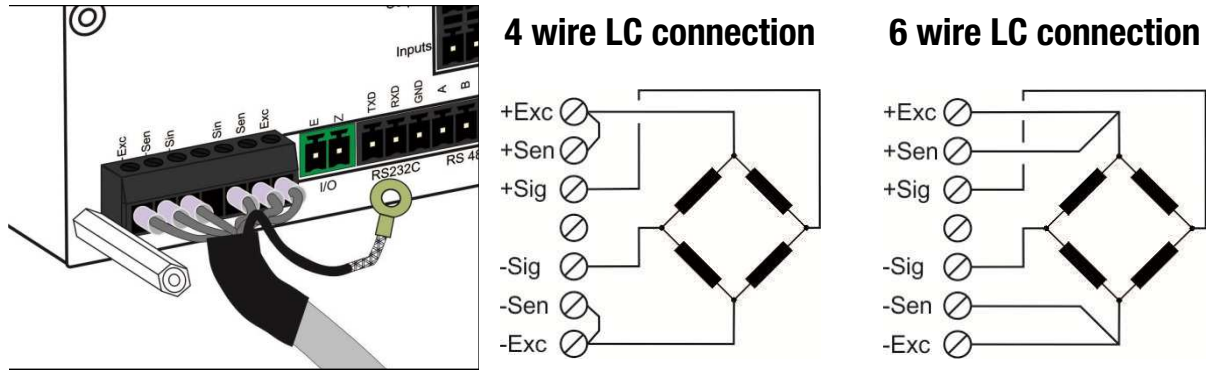

Figure 4-3 - Load cell connections

Warning: Always connect Sense pins to Excitation pins for 4 wire connection. Non-connected sense pins may cause the wrong Excitation voltage measurement and create an accuracy problem.

Warning: Connect the load cell cable shield to the reference ground or shield pin of the load cell connector.

4.3.3 RS 232C Connection

RS 232C port usage and specifications are shown in the table below (Page 47).

Usage	Interfacing with PC or PLC, remote display connection, programming via IndFace1X
Data formats	Continuous, Fast Continuous, Printer Format, BSI Protocol, Modbus-RTU High-Low, Modbus-RTU Low-High
Baud rate	1200 / 2400 / 4800 / 9600 (Default) / 19200 / 38400 / 57600 / 115200 bps
Length and parity	8 bit no parity (Default), 7 bit odd, 7 bit even, 8 bit odd, 8 bit even
Start / Stop bits	1 start bit and 1 stop bit

Table 4-1 - RS-232C Serial Interface Specifications

RS 232C serial connection is done with three wire as indicated below in Figure 4-4.

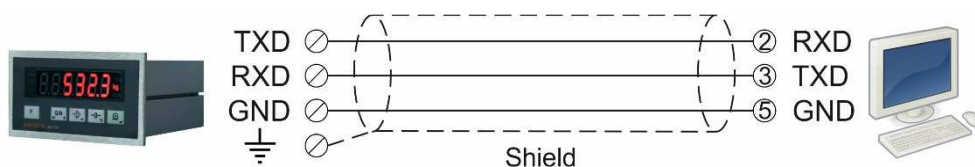

Figure 4-4 - RS 232C serial interface connections

Warning: Connecting the shield to the reference ground will protect your weighing system against EMC disturbances.

4.3.4 RS 485 and Modbus-RTU Connection

RS 485 port usage and specifications are shown in the table below (*Page 48*).

Usage	Interfacing with PC or PLC, remote display, programming via Indface1X,
Data formats	Continuous, Fast Continuous, Printer Format, BSI Protocol, Modbus-RTU High-Low, Modbus-RTU Low-High
Baud rate	1200 / 2400 / 4800 / 9600 (Default) / 19200 / 38400 / 57600 / 115200 bps
Length and parity	8 bit no parity (Default), 7 bit odd, 7 bit even, 8 bit odd, 8 bit even
Start / Stop bits	1 start bit and 1 stop bit

Table 4-2 - RS 485 Serial Interface Specifications

RS 485 serial connection is done with three wires as indicated below in Figure 3-1. Line termination resistors (110 ohm) are needed both ends of the RS 485 line.

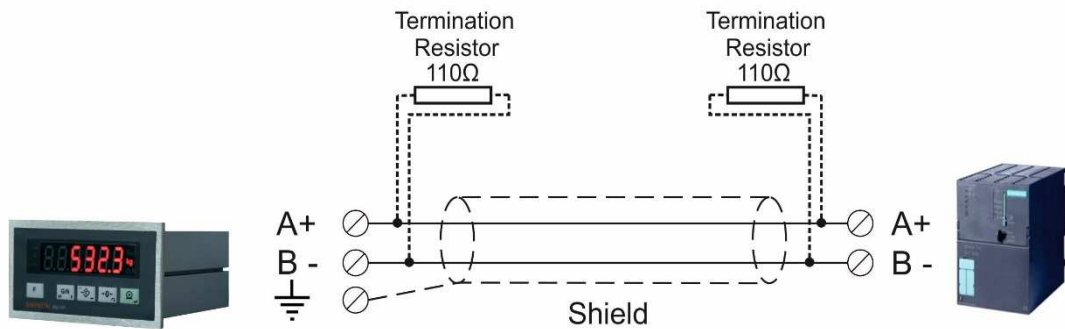

Figure 4-5 - RS485 serial interface connections

Warning: Connect the shield to the reference ground.

Warning: Disconnect IndFace1X PC software before starting Modbus-RTU interfacing.

4.3.5 Profibus Connection (only BX14 PB)

Profibus connection is done as indicated below in Figure 4-6.



Figure 4-6 - BX14 PB serial interface connections

PROFIBUS Connector pin configuration (DB9F)

Pin	Signal	Description
1	-	-
2	-	-
3	B Line	Positive RxD / TxD, RS-485 level
4	RTS	Request to send
5	GND Bus	Ground (isolated)
6	+5V Bus Output	+5V termination power (isolated)
7	-	-
8	A Line	Negative RxD / TxD, RS-485 level
9	-	-
Housing	Cable Shield	Ground

4.3.6 Profinet Connection (only BX14 PN)

Profinet connection is done as indicated below in Figure 4-7.



Figure 4-7 - BX14 PN serial interface connections

PROFINET Connector pin configuration (RJ45)

Pin	Signal	DIR	Description
1	TX+	Out	Differential Ethernet transmit data +
2	TX-	Out	Differential Ethernet transmit data -
3	RX+	In	Differential Ethernet receive data +
6	RX-	In	Differential Ethernet receive data -
4	Not used		Terminated
5	Not used		Terminated
7	Not used		Terminated
8	Not used		Terminated
	Shield		Chasis ground

The HUB connection cabling will be a direct connection as shown below:

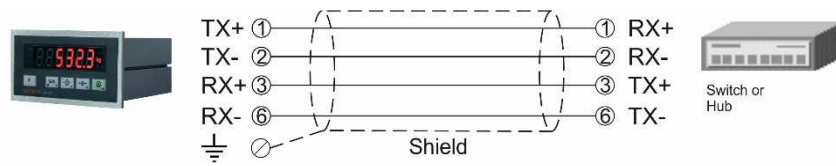

Figure 4-8 - HUB connection

The PC connection cabling will be done via cross cable as shown below. IP address blocks and gateway address of BX14 and PC should be the same in cross connection.

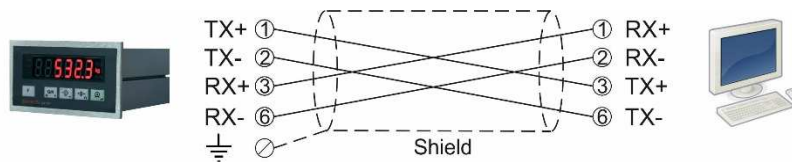

Figure 4-9 - Cross PC connection

Warning: Connect the shield to the reference ground or shield pin of the power connector.

Warning: Disconnect IndFace1X PC software before starting Profinet interfacing.

4.3.7 Ethernet Connection (only BX14 EN)

Ethernet interface is used for data transfer to PC or PLC in the formats shown below.

Usage	Ethernet interface with PC or PLC
Data formats	Continuous, Fast Continuous, Printer Format, BSI Protocol, Modbus TCP/IP High-Low, Modbus TCP/IP Low-High
Ethernet	The Ethernet interface operates at 10Mbit, half duplex

Ethernet Connector pin configuration (RJ45) is ;

Pin	Signal	DIR	Description
1	TX+	Out	Differential Ethernet transmit data +
2	TX-	Out	Differential Ethernet transmit data -
3	RX+	In	Differential Ethernet receive data +
6	RX-	In	Differential Ethernet receive data -
4	Not used		Terminated
5	Not used		Terminated
7	Not used		Terminated
8	Not used		Terminated
	Shield		Chassis ground

The HUB connection cabling will be a direct connection as shown below:

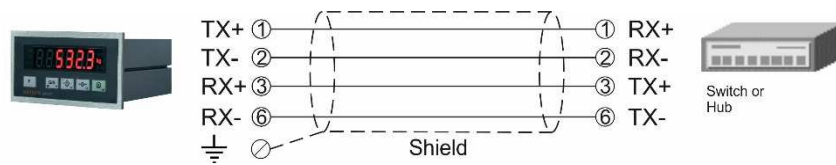

Figure 4-10 - HUB connection

The PC connection cabling will be done via cross cable as shown below. IP address blocks and gateway address of BX14 and PC should be the same in cross connection.

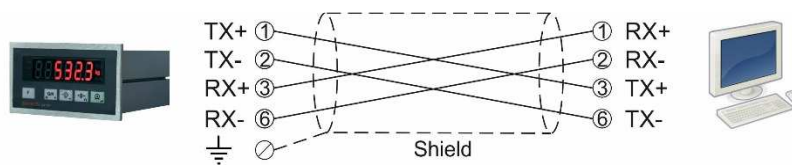

Figure 4-11 - Cross PC connection

Warning: Connect the shield to the reference ground or shield pin of the power connector.

Warning: Disconnect IndFace1X PC software before starting Ethernet interfacing.

4.3.8 CANopen Connection (only BX14 C0)

CANopen connection is done with four wires as indicated below in Figure 4-12. The data line ends must be equipped with 120 ohm bus terminating resistors.

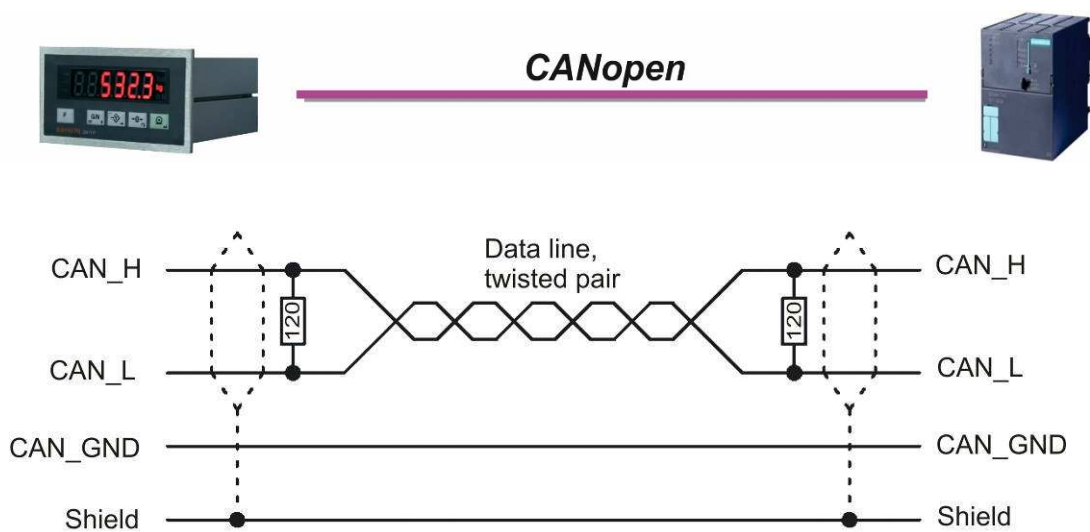

Figure 4-12 - BX14 C0 serial interface connections

CANopen Connector pin configuration (DB9M)

Pin	Signal	Description
1	-	-
2	CAN_L	-
3	CAN_GND	-
4	-	-
5	CAN_SHIELD	-
6	-	-
7	CAN_H	-
8	-	-
9	-	-
Housing	Cable Shield	-

Table 4-3 - BX14 CO serial interface connector

Warning: Connect the shield to the reference ground.

Warning: Disconnect IndFace1X PC software before starting CANopen interfacing.

4.3.9 EtherNet/IP Connection (only BX11 EI)

EtherNet/IP connection is done as indicated below in Figure 4.13.



Figure 4.13 - BX14 EI interface connections

EtherNet/IP Connector pin configuration (RJ45)

Pin	Signal	DIR	Description
1	TX+	Out	Differential Ethernet transmit data +
2	TX-	Out	Differential Ethernet transmit data -
3	RX+	In	Differential Ethernet receive data +
6	RX-	In	Differential Ethernet receive data -
4	Not used		Terminated
5	Not used		Terminated
7	Not used		Terminated
8	Not used		Terminated
	Shield		Chassis ground

The HUB connection cabling will be a direct connection as shown below:

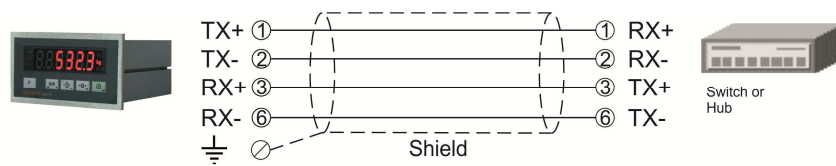

Figure 4.14 - HUB connection

The PC connection cabling will be done via cross cable as shown below. IP address blocks and gateway address of BX14 and PC should be the same in cross connection.

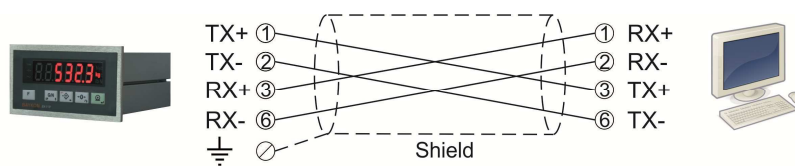

Figure 4.15 - Cross PC connection

Warning: Connect the shield to the reference ground or shield pin of the power connector.

Warning: Disconnect IndFace1X PC software before starting EtherNet/IP interfacing.

4.3.10 EtherCAT Connection (only BX14 EC)

EtherCAT connection is done as indicated below in Figure 4.16.



Figure 4.16 - BX14 EC interface connections

EtherCAT Connector pin configuration (RJ45)

Pin	Signal	DIR	Description
1	TX+	Out	Differential Ethernet transmit data +
2	TX-	Out	Differential Ethernet transmit data -
3	RX+	In	Differential Ethernet receive data +
6	RX-	In	Differential Ethernet receive data -
4	Not used		Terminated
5	Not used		Terminated
7	Not used		Terminated
8	Not used		Terminated
	Shield		Chassis ground

The HUB connection cabling will be a direct connection as shown below:

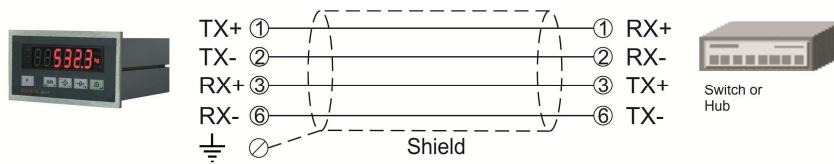

Figure 4.17 - HUB connection

Warning: Connect the shield to the reference ground or shield pin of the power connector.

Warning: Disconnect IndFace1X PC software before starting EtherCAT interfacing.

4.3.11 CC-Link Connection (only BX14 CC)

CC-Link connection is done as indicated below in Figure 4.18.



Figure 4.18 - BX14 CC interface connections

CC-Link Connector pin configuration

Pin	Signal	Description
1	DA	PositiveRS485 Rxd/TxD
2	DB	NegativeRS485 Rxd/TxD
3	DG	Signal ground
4	SLD	Cable Shield
5	FG	Protective Earth

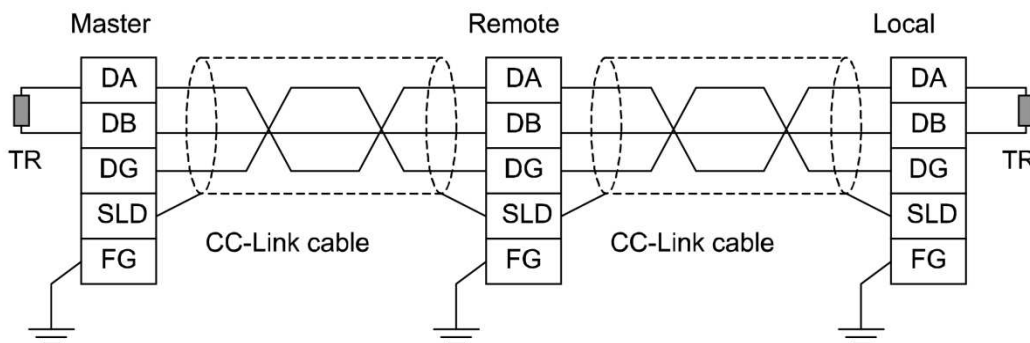

Warning: Connect the shield to the reference ground or shield pin of the power connector.

Warning: Disconnect IndFace1X PC software before starting CC-Link interfacing.

4.3.12 Powerlink Connection (only BX14 PL)

Powerlink connection is done as indicated below in Figure 4.16.



Figure 4.19 - BX14 PL interface connections

Powerlink Connector pin configuration (RJ45)

Pin	Signal	DIR	Description
1	TX+	Out	Differential Ethernet transmit data +
2	TX-	Out	Differential Ethernet transmit data -
3	RX+	In	Differential Ethernet receive data +
6	RX-	In	Differential Ethernet receive data -
4	Not used		Terminated
5	Not used		Terminated
7	Not used		Terminated
8	Not used		Terminated
	Shield		Chassis ground

The HUB connection cabling will be a direct connection as shown below:

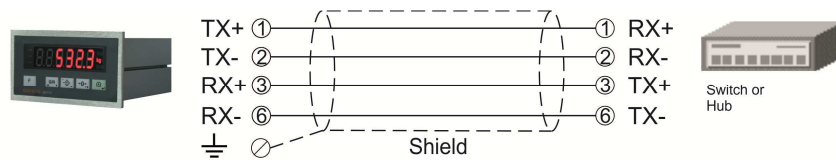
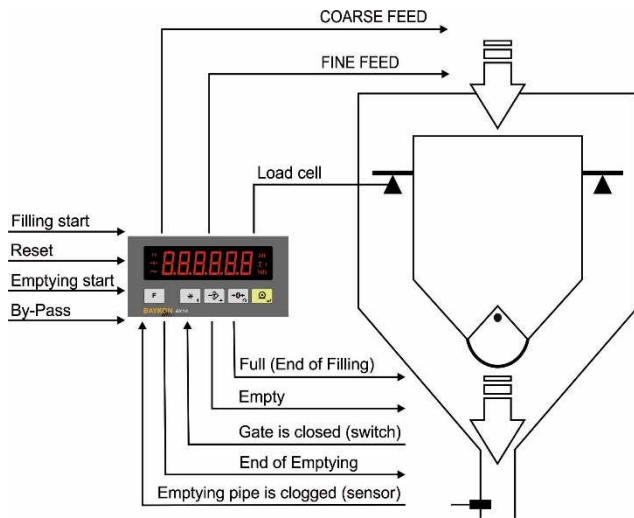

Figure 4.20 - HUB connection

Warning: Connect the shield to the reference ground or shield pin of the power connector.

Warning: Disconnect IndFace1X PC software before starting Powerlink interfacing.

4.3.14 Digital Inputs and Outputs Connection



Digital inputs and outputs of BX14 are used to control the system. 4 inputs and 5 outputs are galvanically isolated. E and Z non-isolated inputs shall have the same DC ground with the weighing controller power supply.

Functions of these inputs and outputs are shown below.

Inputs are 12 – 28 VDC , 10 mA ;
Outputs are 250 VAC or 30VDC, 1A.

Inputs / Outputs	Descriptions
Input 1	Start for filling
Input 2	Start for emptying
Input 3	Gate is closed
Input 4	Reset
E	Emptying pipe is clogged (from sensor on the material transfer pipe)
Z	By-Pass input (By-pass starts 3 seconds later activating the By-pass input.)
Output 1	Coarse feed
Output 2	Fine feed
Output 3	Empty
Output 4	Full (end of filling)
Output 5	End of emptying

Inputs connection diagrams are seen in Figure 4-21 and in Figure 4-22.

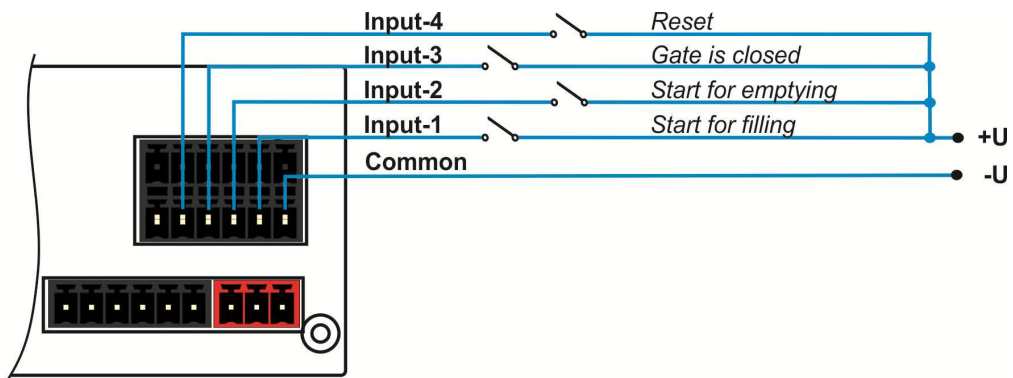

Figure 4-21 – Isolated inputs connection

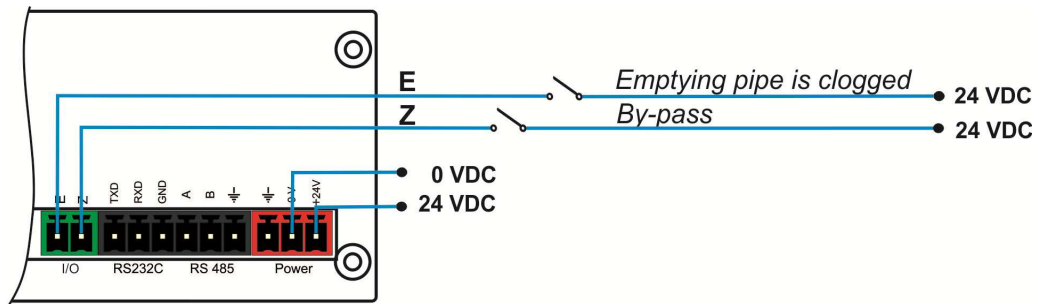

Figure 4-22 – Non-isolated inputs connection

Outputs connection diagram is shown in Figure 4-23.

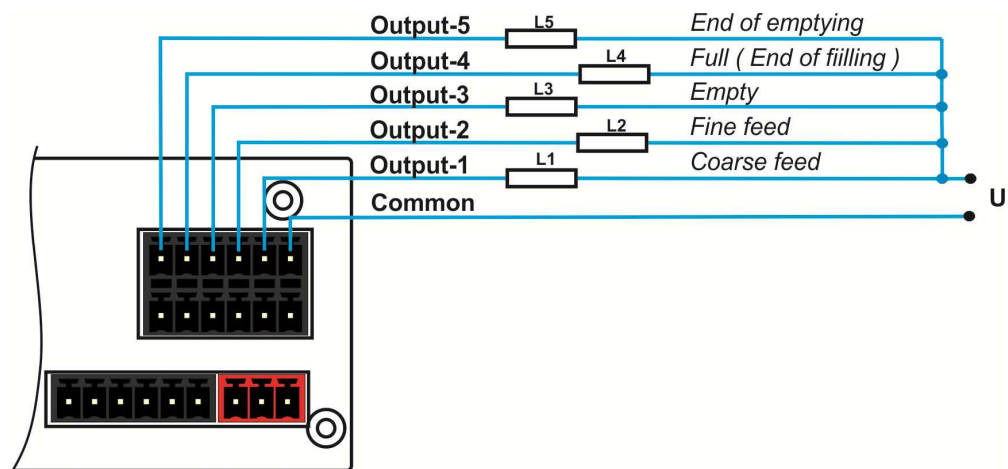

Figure 4-23 - Outputs connection

4.4 Commissioning

PRECAUTION: Please read this manual carefully before energizing the instrument. Perform the commissioning operation according the procedure given in this section. Only trained person is allowed for cleaning, commissioning, checking and servicing of the instrument. The interference of untrained person may cause some unwanted damages or injuries.

After finishing the required installations and connections of BX14, turn the power on and make calibration. After checking the performance of your weighing instrument you can begin to use the controller. Power off the controller for other peripheral connections.

To start up the filling system, please follow as:

1. Connect parallel I/O connector prepared according as described in the filling modes section.
2. Enter Calibration parameters in parameter groups [**21-**] and [**3--**].
3. Enter Programming parameters in parameter group [**5--**].
4. Enter the application related parameters as explained in operation.
5. Enter Target and preset values as explained on *Page 38*.

You can find the process operation, display messages, parameters' descriptions and a connection diagram example, in section 7.

5. SERIAL DATA OUTPUTS

BX14 filling controller family has different kind of serial interfaces like RS232, RS485 and Ethernet etc. In this section, you will find the data structure of different type of the data outputs via these serial ports except field bus interfaces. You will find detailed information on field bus interfacing in the related sections.

5.1 Continuous Data Output

Continuous data output of the instrument is transmitted in the following data structure. The serial ports of BX14 are suitable for bi-directional communication. If, you transmit ASCII codes of P(print), Z(zero), T(tare) or C(clear) letters to the serial port of BX14; the controller will act like the related keys are pressed.

CR (Carriage return) and LF (Line feed) codes can be enabled or disabled from response but they must be sent to end of ASCII command.

CHK (Checksum) can be enabled or disabled from both command and response and only continuous data output can be programmed for more than one interface.

The data format of continuous data output is;

	Status			Indicated						Tare								
STX	STA	STB	STC	D5	D4	D3	D2	D1	D0	D5	D4	D3	D2	D1	D0	CR	LF	CHK

The including of the status bytes STA, STB and STC are ;

Definition Table for Status A (STA)									
Bits 0, 1 and 2				Bits 3 and 4			Bit 5	Bit 6	Bit 7
0	1	2	Decimal point	3	4	Increment size	Always 1	Always 1	X
0	0	0	XXXX00	1	0	X 1			
1	0	0	XXXXX0	0	1	X 2			
0	1	0	XXXXXX	1	1	X 5			
1	1	0	XXXXX.X						
0	0	1	XXXX.XX						
1	0	1	XXX.XXX						
0	1	1	XX.XXXX						
1	1	1	X.XXXXX						

Definition Table for Status B (STB)		
Bit 0	0 = Gross	1 = Net
Bit 1	0 = Weight positive	1 = Weight negative
Bit 2	0 = No Error	1 = Error
Bit 3	0 = Stable	1 = Unstable
Bit 4	Always = 1	
Bit 5	Always = 1	
Bit 6	Always = 0	
Bit 7	x	

Definition Table for Status C (STC)		
Bit 0	Always 0	
Bit 1	Always 0	
Bit 2	Always 0	
Bit 3	Always 0	
Bit 4	Always 1	
Bit 5	Always 1	
Bit 6	Always 0	
Bit 7	x	

$$\text{CHK (Checksum)} = 0 - (\text{STX} + \text{STATUS A} + \dots + \text{LF})$$

Error Messages: UNDER, OVER, A.OUT, L-VOLT, H-VOLT, are represented in Indicated data fields.

Note: The weight data is represented with right aligned and the error messages are represented with left aligned.

5.2 Fast Continuous Data Output

Fast continuous “indicated weight” data output can be used only for the instruments which can communicate fast. The output rate is related with the baud rate. Use higher baud rate for faster data rate. Received ASCII codes of P(print), Z(zero), T(tare) or C(clear) letters, the controller will act like the related keys are pressed. CR and LF can be enabled in the related parameter.

The data format of the fast continuous data output is;
[STX][STATUS][SIGN][WEIGHT VALUE][CR][LF]

Examples :

- ☺S+000123.4 (weight is stable and 123.4)
- ☺D+000123.4 (weight is dynamic and 123.4)
- ☺+ (Over load)
- ☺- (Under load)
- ☺0 (ADC out error)

5.3 Print Mode

The format of the data output in Print mode can be selected in 3 different type forms in the parameter group [**04-**]. Only continuous format is available more than one interface. The print mode output is transmitted automatically after each filling or by pressing < **Print** > key in basic weighing mode (ready status).

Single Line

You can send the data in single line like below by pressing < **Enter** > key.

CN: 21 G: 3.000kg T: 1.000kg N: 2.000kg

CN				GROSS				TARE				NET										
M	S	D		M	S	D		M	S	D		M	S	D		L	F	C	R			
		9				3				13				3				13			1	1

Multi Line Formats

You can send the data in multiple lines as seen in the label given below by pressing < **Enter** > key. The data output structure can be programmed with printer parameters for 2 different printer types.

```
CN      : 69
GROSS   74.250 kg
TARE    12.000 kg
NET     62.250 kg
```

Multi Line-24 Format for wider printers

```
CN : 69
G : 74.250 kg
T : 12.000 kg
N : 62.250 kg
```

Multi Line-16 Format for 16 character printers

5.4 BSI Data Structure

All new generation BAYKON instruments launched on the market support the standardized command set BSI data form, depending on the functionality of the instrument. This easy data format gives the reliable and speedy interface advantages with communicating PLC or PC for process control or transactional applications. You can expand your system with additional scales from BAYKON without having to change your application program base.

General Rules:

1. Commands are only in CAPITAL.
2. CHK (2 ASCII char) can be enabled or disabled from both command and response.
3. Weight data is 8-byte with dot and non-significant zeros on the left.
4. Address (2 ASCII char) will be located in the structure, if not 00.

Command format:

A general description of the command is the following:

[ADR][COMMAND][CHK][CR][LF]

Response format with weight :

A general description of the response is the following:

[ADR][COMMAND][STATUS][SIGN][WEIGHT/FORCE][CHK][CR][LF]

Response format without weight :

[ADR][COMMAND][STATUS][CHK][CR][LF]

Command Table:

A	Read all weight data immediately
B	Read Gross weight value immediately
C	Clear the tare memory
F	Start /stop continuous data output
G	Read voltage value of DC power supply
I	Read current weight (indicated) value immediately
P	Print: Read the current stable weight value
S	Read Status
T	Tare
U	Read digital inputs
V	Read digital outputs
X	Read current weight value in increased resolution immediately
Z	Zero

Status Table:

A	Ack, the command is operated successfully
D	Dynamic, unstable weight
E	Errors except of H, L, O, +, -.
H	High voltage detected
I	The weight is in range
L	Low voltage detected
N	Nack, the command couldn't be operated
O	ADC out
S	Stable weight
X	Syntax error (not recognized the received command)
+	Overload
-	Under load

Note: CHK, CR and LF will not be shown in below data format descriptions in this section.

Commands and Responses:

A	Read all weight data
----------	----------------------

Command : [ADR][A]

Response : [ADR][A][STATUS][SIGN][NET W][SIGN][TARE W][SIGN][GROSS W]

Example :

Command : 01A

Response : 01AS+000123.4+000111.1+000234.5

01AD+000123.4+000111.1+000234.5

01AO (ADC out error)

Comments :

The response is net, tare and gross weight values or error status.

All weight data is transmitted immediately after receiving the command.

B	Read Gross weight
----------	-------------------

Command : [ADR][B]

Response : [ADR][B][STATUS][SIGN][WEIGHT VALUE]

Example :

Command : 01B

Response : 01BS+000123.4 (gross weight is stable and 123.4)

01BD+000123.4 (gross weight is dynamic and 123.4)

01B- (under load)

Comments :

The response is the gross weight value (stable or dynamic) or error status.

Gross weight data is transmitted immediately after receiving command.

C	Clear the tare memory
----------	-----------------------

Command : [ADR][C]

Response : [ADR][C][A] (Cleared and the scale is in gross mode)

Comments :

The response status is always Ack in weighing or force mode.

F	Start /stop continuous data output
----------	------------------------------------

Command : [ADR][F][ENABLE/DISABLE]

Response : [ADR][F][STATUS]

Example :

Command : 01F1 (Enable)

01F0 (Disable)

Response : 01FA (Command is done successfully)

01FN (Command could not executed)

Comments :

Indicated weight value sends continuously.

Continuous data format is [ADR][I][STATUS][SIGN][WEIGHT VALUE].

G	Read voltage value of DC power supply
----------	---------------------------------------

Command : [ADR][G]

Response : [ADR][G][STATUS][VOLTAGE VALUE]

Example :

Command : 01G

Response : 01GA234 (Power supply is 23.4 VDC)

01GA150 (Power supply is 15.0 VDC)

01GA090 (Power supply is 9.0 VDC)

Comments :

Voltage value is 3 byte and sends with 0.1 V increment.

I	Read indicated weight
----------	-----------------------

Command : [ADR][I]

Response : [ADR][I][STATUS][SIGN][WEIGHT VALUE]

Example :

Command : 01I

Response : 01IS+000123.4 (weight is stable and 123.4)

01ID+000123.4 (weight is dynamic and 123.4)

01I+ (overload)

Comments :

Indicated weight value (stable or dynamic) is transmitted immediately.

The weight value may be in gross or net.

P	Print :Read the stable weight
----------	-------------------------------

Command : [ADR][P]

Response : [ADR][P][STATUS][SIGN][WEIGHT VALUE]

Example :

Command : 01P

Response : 01PS+000123.4 (weight is stable and 123.4) or

01PN (could not print)

Comments :

Checks status and it must be stable. Else Nack status is send.

Status can be Stable or Nack.

S	Read Status
----------	-------------

Command : [ADR][S]

Response : [ADR][S][STATUS-1][STATUS-2][STATUS-3]

Example :

Command : 01S

Response : 01SSGI (Stable, Gross, In Range)

01SDGL (Dynamic, Gross, Low voltage error)

Comments :

The response includes 3 status information.

STATUS-1 can be **Stable** or **Dynamic**.

STATUS-2 can be **Gross** or **Net**.

STATUS-3 can be 'In range', 'Out of range', '+ Over', '- Under', 'Low voltage', 'High voltage' or 'Errors'.

T	Tare
----------	------

Command : [ADR][T]

Response : [ADR][T][A] (Taring is done successfully and scale is in net)

[ADR][T][N] (Taring could not executed)

[ADR][T][X] (Taring is disabled)

Comments :

The tare value is overwritten by the new tare weight value.

Status must be stable in 2 seconds time out delay. If so, Ack is send.

If it cannot be stable in time out delay, Nack is send.

U	Read digital inputs
----------	---------------------

Command : [ADR][U]

Response : [ADR][U][A][Inputs]

Example :

Command : 01U

Response : 01UA23 (Input 2 and Input 1 are active)

01UA4296 (Input 15,10,8,5,3,2 are active)

01UAFF (All 8 inputs are active)

01UN (Could not read inputs)

Comments :

Data length change according to number of digital inputs.

Inputs are implemented to ASCII char of 4-bit. '1111' inputs are implemented to char 'F'.

INPUTS	IN-16	IN-15	IN-14	IN-13	IN-12	IN-11	IN-10	IN-9	IN-8	IN-7	IN-6	IN-5	IN-4	IN-3	IN-2	IN-1
Bit wise	0	1	0	0	0	0	1	0	1	0	0	1	0	1	1	0
ASCII	4				2				9				6			

V	Read digital outputs
----------	----------------------

Command : [ADR][V]

Response : [ADR][V][A][Outputs]

Example :

Command : 01V
Response : 01VA03 (Output 2 and Output 1 are active)
 01VA4296 (Output 15,10,8,5,3,2 are active)
 01VAFF (All 8 outputs are active)
 01VN (Could not read outputs)

Comments :

Data length change according to number of digital outputs.

Outputs are implemented to ASCII char of 4-bit. '1111' is implemented to char 'F'.

OUTPUTS	OUT-16	OUT-15	OUT-14	OUT-13	OUT-12	OUT-11	OUT-10	OUT-9	OUT-8	OUT-7	OUT-6	OUT-5	OUT-4	OUT-3	OUT-2	OUT-1
Bit wise	0	1	0	0	0	0	1	0	1	0	0	1	0	1	1	0
ASCII	4				2				9				6			

X	Read weight value in increased resolution
----------	---

Command : [ADR][X]

Response : [ADR][X][STATUS][SIGN][WEIGHT VALUE]

Example :

Command : 01X

Response : 01XS+00123.41 (weight is stable and 123.41) or
 01XD+00123.41 (weight is dynamic and 123.41) or
 01XE (Error)

Comments :

The response includes weight data with divided the increment to 10.

Z	Zero
----------	------

Command : [ADR][Z]

Response : [ADR][Z][A] (Zeroed)
 [ADR][Z][N] (Zeroing could not be operated)
 [ADR][Z][X] (Zeroing is disabled)

Comments :

Zero command cannot work in net weighing.

Weight must be in zeroing range for all operating modes.

Status must be stable in 2 seconds time out delay. If so, Ack is send.

If it cannot be stable in time out delay, Nack is send.

Checksum Calculation:

CHK is transmitted as two ASCII characters calculated with the Checksum formulation.

Checksum = 0 – (SUM of all response data before CHK)

Example: Read stable current weight data.

BSI Examples: (CHK is enabled and instrument address is 01)

Command: 01P[CHK][CR][LF]











Checksum = 0 – (0x30 + 0x31 + 0x50)
= 0 – 0XB1
= 0x4F
= Char '4' and 'F'

Response: 01PS+000123.4[CHK][CR][LF]

Checksum = 0 – (0x30 + 0x31 + 0x50 + 0x53 + 0x2B + 0x30 + 0x30 + 0x30 + 0x31 + 0x32 + 0x33 +
0x2E + 0x34)
= 0 – 0x02B7
= 0x49
= Char '4' and Char '9'

6. FILLING TARGET AND PRESET VALUES' ENTRY

Filling related target, coarse lead in and fine lead in values are entered by pressing < * > key and following the table below.

Display	Operation
[123.456 kg]	Press  key to enter the menu. [tArGEt] prompt seen.
[tArGEt] ↻ [XXXXX]	<p>Filling Target Entry</p> <p>Target prompt and its value are toggled on the display.</p> <p>Enter target value by pressing  and  keys.</p> <p>Press the  key to go to the next parameter.</p>
[CoArSE] ↻ [XXXXX]	<p>Preset Values (Cut-off) Entry</p> <p>Coarse prompt and its value are toggled on the display.</p> <p>Coarse lead in = Target – Coarse cut-off</p> <p>Enter coarse value by pressing  and  keys.</p> <p>Press the  key to go to the next parameter.</p>
[FinE] ↻ [XXXXX]	<p>Fine prompt and its value are toggled on the display.</p> <p>Fine lead in = Target – Fine cut-off</p> <p>Enter fine value by pressing  and  keys.</p> <p>Press the  key to go back to the operation.</p>

Warning:

- 1) Changing target value does not require changing the coarse lead in and fine lead in values.
- 2) Coarse and fine values must be entered carefully to start filling.

7. OPERATION

BX14 discontinuous weighing controller is a controller which controls the flow rate of the material and transfers the material to the preset total target value. Flow rate is adjusted automatically to the flow rate target value. If total target value is entered, weighing controller adjusts the filling weights automatically for accurate transfer of the material. The flow rate, estimated daily total, and total value can be displayed.



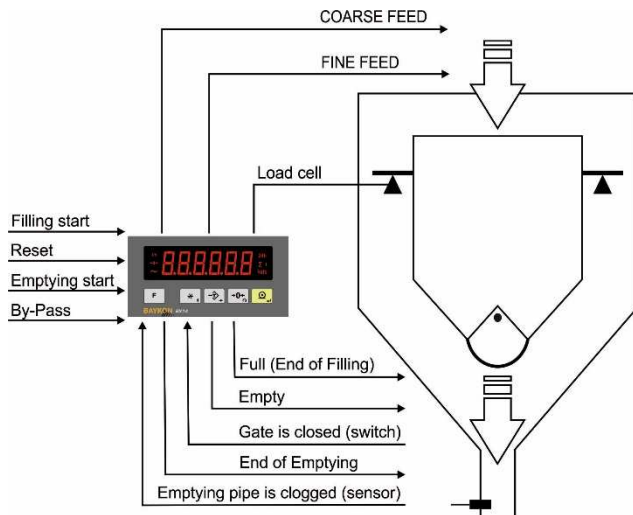



Weighing Operation :

















- The weighing controller is emptied the hopper after applying filling start input.
- The hopper is filled up to target value accurately in 2 speeds.
- The filled hopper is emptied after applying emptying start input, if emptying pipe is not clogged.
- Emptying time is changed automatically to control the flow rate target.
- The material transfer is goes on until removing filling start input.
- Automatic target value adjustment for total of material transfer accuracy.

Application Related Parameters :

The application related parameters shall be entered before start up the weighing process. Please enter the values below carefully for better system performance.

Display	Operation
[123.456 kg]	Press long  key, [ton-hr] prompt seen.
[ton-hr] ↻ [XXXXX]	<p>Flow rate. If the application is required the material flow rate control, enter the flow rate by pressing  and  keys. Press the  key to go to the next parameter.</p> <p>The [0] value operates the system without flow control.</p>
[S-Qty] ↻ [XXXXX]	<p>Sampling Quantity. Flow rate is calculated with the last transferred material at sampling quantity weighing. Increasing the sampling quantity gives more accurate result with longer settling time. This value should be optimized for the best system response.</p> <p>Enter the sampling quantity value by pressing  and  keys. Press the  key to go to the next parameter.</p>

<p>[t-trgt] ↻ [XXXXX]</p>	<p>Total target. If this parameter value is bigger than zero, the controller adjusts filling target automatically to transport the total target of material. Operation ends after transferring the material at total target value. [000000] means continuous operation without total control.</p> <p>Enter the total target value by pressing  and  keys. Press the  key to go to the next parameter.</p>
<p>[Zero_r] ↻ [XXXXX]</p>	<p>Zero range. If the weigh is decreased in this range at Emptying, the scale is accepted empty and the gate is closed.</p> <p>Enter zero range value by pressing  and  keys. Press the  key to go to the next parameter.</p>
<p>[d-diSC] ↻ [X.X]</p>	<p>End of emptying delay. After the weight value goes into zero range at emptying, this parameter delays closing the gate for completely emptying.</p> <p>Enter the value by pressing  and  keys. Press the  key to go to the next parameter.</p> <p>Maximum value is 9.9 seconds. Default is 0.0 seconds.</p>
<p>[d_gAtE] ↻ [X.X]</p>	<p>Gate control delay. This parameter has two functions;</p> <ol style="list-style-type: none"> 1. If there is no gate switch (GAT_Ch = 0), this time delays "End of emptying" output. 2. If there is a gate switch (GAT_Ch = 1), this time delays to check the gate position. <p>Enter gate control delay value by pressing  and  keys. Press the  key to go to the next parameter.</p> <p>Maximum value is 9.9 seconds. Default is 0.0 seconds.</p>
<p>[GAT_Ch] ↻ [X]</p>	<p>Gate position check</p> <p>0 = No gate switch 1 = Gate switch function is enable</p> <p>Enter gate position check value by pressing  and  keys. Press the  key to go back to the operation.</p> <p>Default is "0".</p>

Application Related Display Messages :

The messages below are shown on the display in the filling cycle or if there is any error in the filling.

Display	Operation
[-Zero-]	It is displayed during automatic zeroing before feeding. Refer to par. [506].
[GAtE]	It is displayed during gate position control.
[FuLL] ↻ [XXXXX]	This prompt is displayed at the end of Filling by toggling with the weight value. It disappears when emptying starts.
[d_dEL]	Emptying delay time in function.
[End]	The total target of material is transferred and operation is ended. If "filling start" input comes after this message, Total-1 value is cleared and starts next batch.
[bYPASS]	By-Pass operation. Feeding and Empty outputs are activated and ton/hour value is cleared at By-pass operation. "emptying pipe is clogged" sensor is in function at by-pass operation.
[E GAtE]	Gate position error.
[E FEEd]	This message is appeared by the "emptying pipe is clogged" sensor to announce the emptying process is paused. The message disappears automatically after opening the pipe line.
[nO FEEd]	Feeding error message appears, if weight value is not increased in a preset time (refer to parameter [508]). In this case, status of feeding outputs do not change. The message disappears as automatically after starting the feeding.

Application Related Information on the Display :

The information below are shown on the display by pressing < F > key sequentially;

Display	Description
1/h and unit	The actual flow rate. To change the flow rate enter to the application related parameters.
24h and unit	Estimated 24h total. Calculated daily total, if system's flow rate is equal to the actual flow rate at the following 24 hours.
Σ	Total. The total values are displayed at accuracy defined by parameter [200] until displaying over range. [------] prompt announced to warn over range at OIML usage ; or the decimal point is disabled to increase the total value displaying range at non- OIML applications before displaying [------] prompt.

To clear the Total, press < **Zero** > key at this prompt at basic weighing mode. Press < **Enter** > key for clearing the total at [Clear] prompt. Or press < **F** > key to escape.

To display another total refer to parameter [116] (Page 52).

Filling cycle :

Press < **Zero** > key if the scale is not indicated zero after powered on. Apply filling start input to start the weighing. Flow rate control is done as shown below.

If the weight is more than zero range, the hopper is emptied after applying the filling start input. 2 speed feeding is started after automatic zeroing the scale. The [**FuLL**] prompt is displayed after end of the filling. If the start emptying input is active, the hopper is emptied.

The controller calculates the flow rate after each filling and adjusts the flow rate automatically to the flow rate target value.

The process ends after deactivating the filling start input and emptied the last filled material.

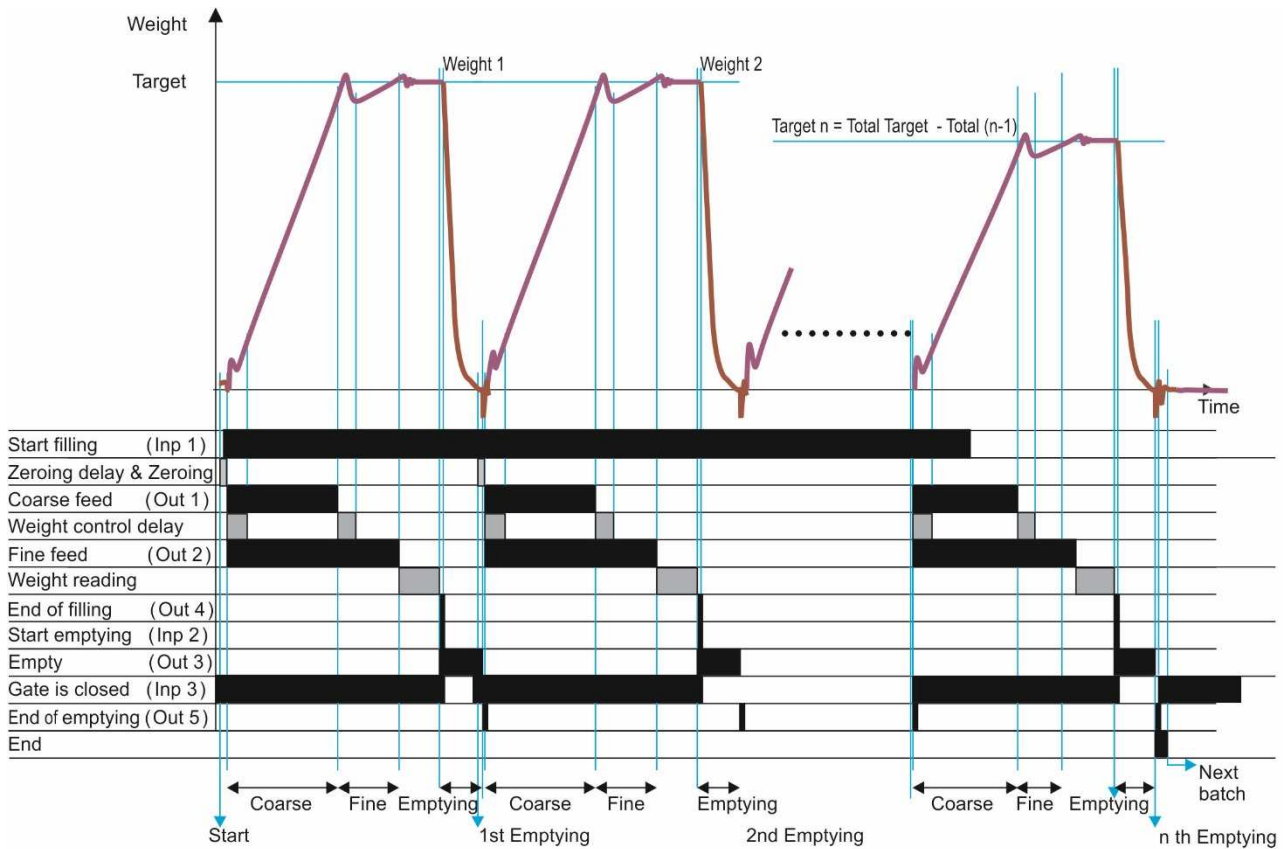

Notes :

The fine feed output is activate together with coarse feed output if parameter [501] is 1 as indicated in the drawing above. If this parameter is adjusted to 0, the fine feed output is activated after coarse feeding.

Digital Inputs and Outputs Connection :

I / O	Descriptions
Input 1	Start for filling
Input 2	Start for emptying
Input 3	Gate is closed
Input 4	Reset

E	Emptying pipe is clogged (from sensor on the material transfer pipe)
Z	By-Pass input (By-pass starts 3 seconds later activating the By-pass input.)
Output 1	Coarse feed
Output 2	Fine feed
Output 3	Empty
Output 4	Full (end of filling)
Output 5	End of emptying

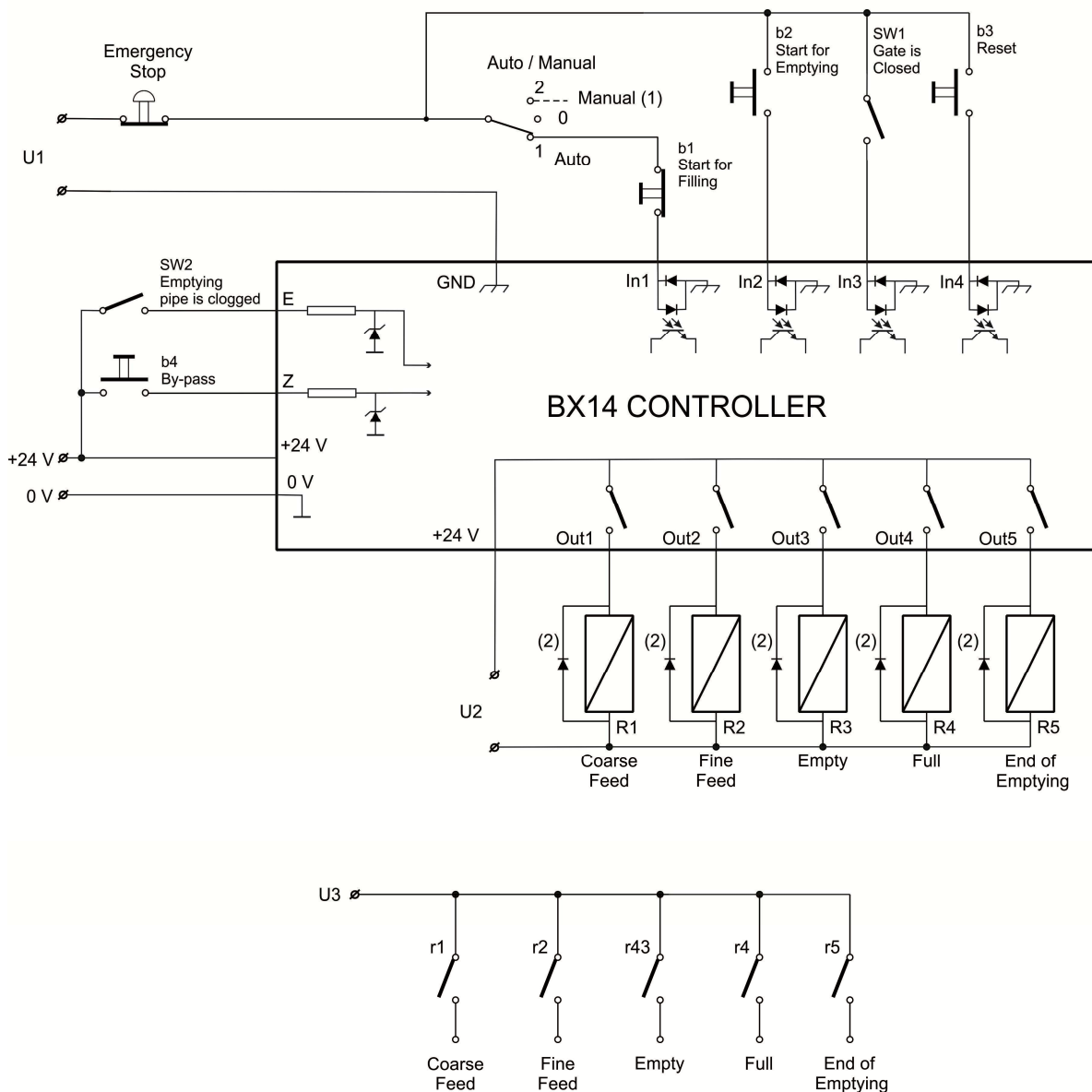

Example of a Connection Diagram :



(1) Manual control circuitry is not indicated.





8. PROGRAMMING AND CALIBRATION

In this section you will find the programming and calibration procedure of BX14 indicator according to your application. The signs those take place on the lower right corner of the keys indicate the function of the keys in programming menu. The basic meanings of these keys are given the table below.

				
Exit without saving	Advancing next parameter	Select the digit will be changed	Changing parameter value or increasing the blanking digit	Enter

8.1 Entering the Programming and Calibration







The calibration DIP switch (*Page 16*) should be “ON” to change the metrological related parameters (grey colored boxes on the next page).

Display	Operation
[123.456 kg]	Press  key until [PASSWr] prompts seen.
[PASSWr]	Press  +  +  keys sequentially.
[---]	Press  key for confirm.
[0--]	First block of Programming menu.

Programming and Calibration menu consist of main blocks which are shown as [**X**--] and sub-blocks. By using < ↑ > key you can reach next main blocks. After reaching the desired main block, you can get in by pressing < **Enter** > key. As you enter the block you will reach the first sub-block in that main block. The sub-block address will be seen on the display as [**X0**-]. You can also search between the sub-blocks by using < ↑ > key and reach the first parameter of the sub-block seen on the display by pressing < **Enter** > key. The number of the parameter comes on display as [**XY0**]. Again you can search between parameters by < ↑ > key. For entering numerical value in the parameters, press the < **Tare** > key to select the digit and press the < **Zero** > key the change the value.

8.2 Fast Access to the Calibration

The instrument has fast access calibration feature to earn time to the service technician. If only the calibration adjustment is needed, follow the steps below to access the calibration parameters fast.

Display	Operation
[123.456 kg]	Press  key until [PASSWr] prompts seen.
[PASSWr]	Press  +  +  keys sequentially.
[---]	Press  key for confirm.
[310]	Zero Adjustment parameter.
“Calibration”	Press  key to start zero adjustment. Or press  key to access span calibration without zero adjustment.

8.3 Exiting the Programming and Calibration

If you press < **F** > key on which parameter you are, you will get out of the active sub-block and reach the next sub-block. If you press < **F** > key again, you will get out of the active block and reach the next main block. If you press < **F** > key once again, the [**SAvE**] message appears on the display. Here you can press < **Enter** > key to save the changes into the memory, or you can press < **Tare** > key to store the changes until the power goes off, or you can press < **F** > key to abort changes. [**Wait**] message will be seen on the display for a little while, and automatically get back to weighing mode.

Especially for legal metrological usage, please don't forget to turn the power off and “OFF” position the calibration DIP switch to start operation.

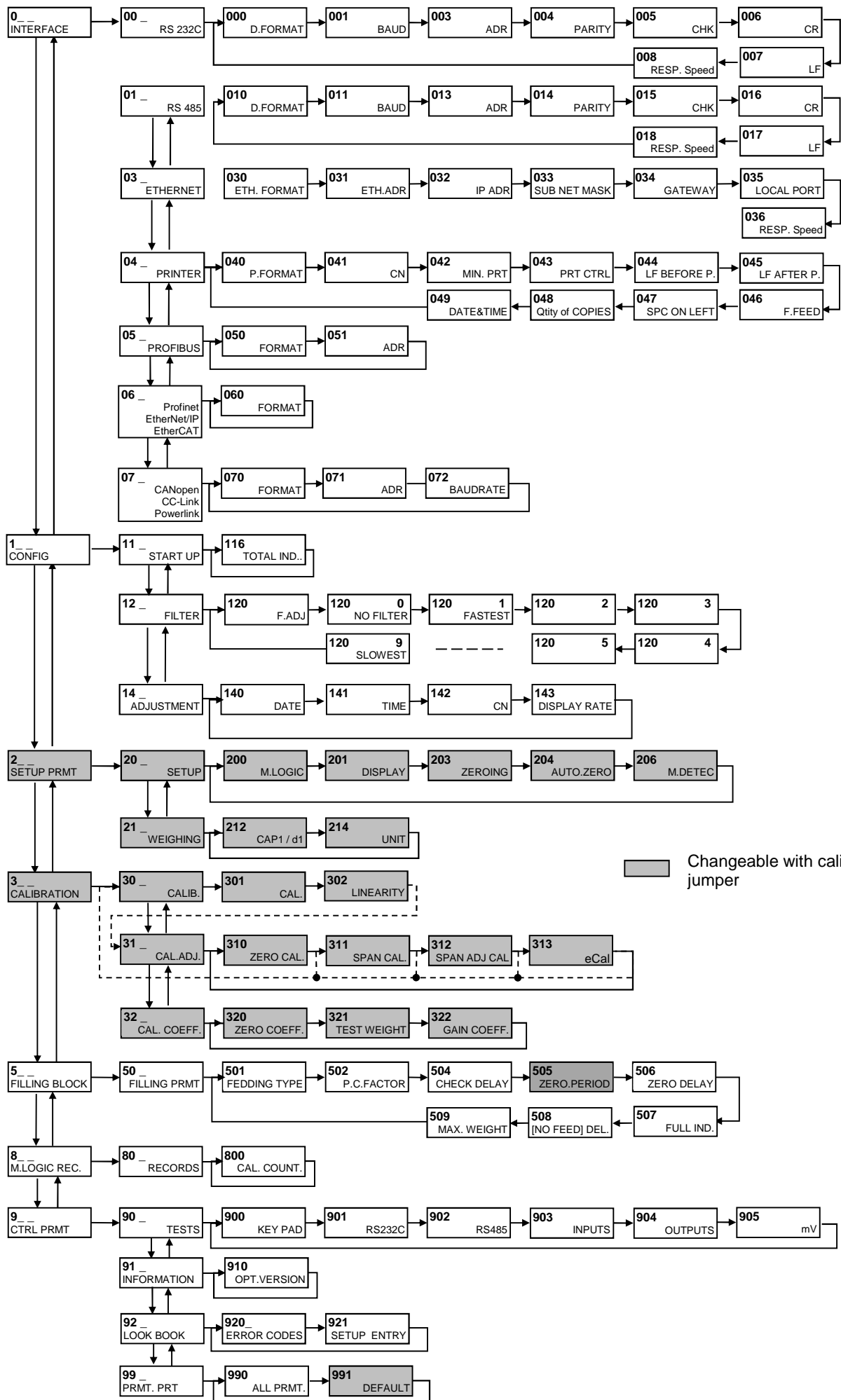

8.5 Programming

[0--] Interface Block

You can reach the parameters about serial interface of BX14 indicator in this section. The data output modes can be used once except continuous data output.

[00-] RS 232C Serial Port

This sub-block includes the parameters about the 1st serial interface of BX14.

[000 3] Data Format

- 0 : No data transfer.
- 1 : Continuous data output (*) (Page 29)
- 2 : Print mode (Parameter [040] on Page 50)
- 3 : BSI command set (Page 31)
- 4 : Modbus RTU High-Low (Page 62)
- 5 : Modbus RTU Low-High (Page 62)
- 6 : Fast continuous mode (Page 30)

*(*) Warning : Use for Baykon remote displays interfacing. CR and LF should be enabled.*

[001 3] Baud Rate

- | | | |
|----------------|-----------------|----------------|
| 0 : 1200 Baud | 1 : 2400 Baud | 2 : 4800 Baud |
| 3 : 9600 Baud | 4 : 19200 Baud | 5 : 38400 Baud |
| 6 : 57600 Baud | 7 : 115200 Baud | |

[003 00] Address

You can define a device address between 1 and 99 by this parameter. If you enter 0, controller will operate without an address.

[004 0] Data length and parity

- 0 : 8 bit, no parity
- 1 : 7 bit, odd parity
- 2 : 7 bit, even parity
- 3 : 8 bit, odd parity
- 4 : 8 bit, even parity

[005 0] Checksum

You can enable or disable for continuous data format and BSI command set.

- 0 : No checksum
- 1 : Checksum enable

[006 1] Carriage return

You can enable or disable for continuous data format.

0 : No CR 1 : CR enables

[007 1] Line feed

You can enable or disable for continuous data format.

0 : No LF 1 : LF enables

[008 0] Response Speed

0 : Modbus RTU Answer is sent immediately after Request is received.

1 : Modbus RTU Answer is delayed 20 msec after Request is received.

This property is very helpful for slow PLC systems

[01-] RS 485 Serial Interface

This sub-block includes the parameters about the 2nd serial interface of BX14.

[010 5] Data Format

0 : No data transfer.

1 : Continuous data output (*) (Page 29)

2 : Print mode (Parameter [040] on Page 50)

3 : BSI command set (Page 31)

4 : Modbus RTU High-Low (Page 62)

5 : Modbus RTU Low-High (Page 62)

6 : Fast continuous mode (Page 30)

(*) Warning : Use for Baykon remote displays interfacing. CR and LF should be enabled.

[011 3] Baud Rate

0 : 1200 Baud 1 : 2400 Baud 2 : 4800 Baud

3 : 9600 Baud 4 : 19200 Baud 5 : 38400 Baud

6 : 57600 Baud 7 : 115200 Baud

[013 01] Address

You can define a device address between 1 and 99 by this parameter. If you enter 0, controller will operate without an address.

[014 0] Data length and parity

0 : 8 bit, no parity

1 : 7 bit, odd parity

- 2 : 7 bit, even parity
- 3 : 8 bit, odd parity
- 4 : 8 bit, even parity

[015 0] Checksum

You can enable or disable for continuous data format and BSI command set.

- 0 : No checksum
- 1 : Checksum enable

[016 1] Carriage return

You can enable or disable for continuous data format.

- 0 : No CR
- 1 : CR enables

[017 1] Line feed

You can enable or disable for continuous data format.

- 0 : No LF
- 1 : LF enables

[018 0] Response Speed

- 0 : Modbus RTU Answer is sent immediately after Request is received.
- 1 : Modbus RTU Answer is delayed 20 msec after Request is received.
This property is very helpful for slow PLC systems

[03-] Ethernet (Only BX14 EN)

This sub-block includes the parameters related with the Ethernet of BX14 controller.

[030 5] Data Format

- 0 : No data transfer.
- 1 : Continuous data output (*Page 29*)
- 2 : Print mode (*Parameter [040] on Page 50*)
- 3 : BSI command set (*Page 31*)
- 4 : Modbus TCP High-Low (*Page 90*)
- 5 : Modbus TCP Low-High (*Page 90*)
- 6 : Fast continuous mode (*Page 30*)

[031 001] Device Address

The address of BX14 will be entered between 000 to 255.

[032] IP Address

The IP address will be entered as " aaa.bbb.ccc.ddd ". Default is "192.168.16.250".

For changing the IP address, press the < **Tare** > key and enter the first 3 “a” digits of the IP address. Press < **Enter** > key to access the following “b”, “c” and “d” address entries.

Press the < ↑ > key to access the next parameter.

[033] Subnet Mask Address

The IP address will be entered as ” aaa.bbb.ccc.ddd ”. Default is “255.255.255.000”.

For changing the IP address, press the < **Tare** > key and enter the first 3 “a” digits of the IP address. Press < **Enter** > key to access the following “b”, “c” and “d” address entries.

Press the < ↑ > key to access the next parameter.

[034] Gateway Address

The IP address will be entered as ” aaa.bbb.ccc.ddd ”. Default is “192.168.16.253”.

For changing the IP address, press the < **Tare** > key and enter the first 3 “a” digits of the IP address. Press < **Enter** > key to access the following “b”, “c” and “d” address entries.

Press the < ↑ > key to access the next parameter.

[035] Local Port

The local port will be entered between 00001 to 65535. Default is “502”.

[036 0] Response Speed

0 : Modbus TCP Answer is sent immediately after Request is received.

1 : Modbus TCP Answer is delayed 20 msec after Request is received.

2 : Modbus TCP Answer is delayed 50 msec after Request is received.

This property is very helpful for slow PLC systems

[04-] Printer

If one of the serial interfaces is selected as printer, the label settings will be made in his sub-block.

[040 2] Print Out Format

1 : Single line (*Page 30*)

2 : Multi line-24 (*Page 31*)

3 : Multi line-16 (*Page 31*)

[041 1] CN (Consecutive Number)

0 : The “Consecutive Number” will not be located on the printout.

1 : The “Consecutive Number” will be located on the printout.

[042] Minimum Print

[**XXXXXX**] If the weight is less than the value entered here, the data will not be printed.

[043 0] Print Method

- 0 : Printing via key.
- 1 : Auto print.
- 2 : Print interlock

Explanation: If this parameter selected as auto print, the data will automatically be printed when the data exceeds minimum print value and become stable. The weight value should decrease under minimum print value to reprint. If this parameter selected as print interlock, after printing the weight must be changed to reprint.

[044 XY] Line Feed Before Printing

- X=0,1 : 0 means the forward feeding and 1 means the backward feeding.
- Y=0,1,2...9 : Enter the number of the feed lines before data printing

[045 XY] Line Feed After Printing

- X=0,1 : 0 means the forward feeding and 1 means the backward feeding.
- Y=0,1,2...9 : Enter the number of the feed lines after data printing

[046 0] Form Feed

- 0 : No Form Feed
- 1 : After printing, the printer will go to next page automatically.

[047 3] Space on the left

Here you can enter the number to shift the printout to the right on the paper.
Available values are from 0 to 9.

[048 1] Quantity of Copies

- X = 1,2...9 : Enter the label quantity for each weighing.

Note: This function is valid only for 040 = 2 or 3.

[049 0] Date/Time

- 0 : No Date/Time .
- 1 : Date/Time in DD/MM/YY format.
- 2 : Date/Time in MM/DD/YY format.
- 3 : Date/Time in YY/MM/DD format.

[05-] Profibus (Only BX14 PB)

This sub-block includes the parameters related with the Profibus interfaces of BX14 controller.

[050 0] Data Format

- 0 : Signed 32 bit integer, no decimal point implied
- 1 : 32 bit float, decimal point implied

[051 000] Rack Address

The Profibus rack address of BX14 will be entered via keypad between 001 to 125.

[06-] Profinet, EtherNet/IP or EtherCAT (Only BX14 PN, BX14 EI or BX14 EC)

This sub-block includes the parameters related with the Profinet, EtherNet/IP or EtherCAT interfaces of BX14 controller.

[060 0] Data Format

- 0 : Signed 32 bit integer, no decimal point implied
- 1 : 32 bit float, decimal point implied

[07-] CANopen, CC-Link or Powerlink (Only BX14 CO, BX14 CC or BX14 PL)

This sub-block includes the parameters related with the CANopen, CC-Link or Powerlink interfaces of BX14 controller.

[070 0] Data Format

- 0 : Signed 32 bit integer, no decimal point implied
- 1 : 32 bit float, decimal point implied

[071 000] Rack Address

The rack address of BX13 will be entered via keypad between 001 to 239.

[072 0] Baudrate (Only CC-Link)

- | | | |
|--------------|--------------|--------------|
| 0 : 156 kbps | 1 : 625 kbps | 2 : 2,5 Mbps |
| 3 : 5 Mbps | 4 : 10 Mbps | |

[1--] Configuration Block

In this block the parameters take place which are being used to set BX14 according to your application.

[11-] Start Up

[116 0] Total Indication

The parameter defines total indication at basic weighing mode by pressing < F > key.

- 0 : Total-1 (Erasable total).
- 1 : Total-2 (The current day's total).
- 2 : Total-3 (Non-erasable total).

Explanation: If this parameter selected as Total-1, To clear the weight Total-1, you need to press < **Zero** > key while the Total-1 value is seen on the display and [**Clear**] will appear on the display. You can confirm deletion by pressing < **Enter** > key or cancel by pressing < **F** > key.

Note: Total-2 (The current day's total) value is transferred to Total-4 (Yesterday's total) when the time is 00:00 o'clock after Total-2 value is cleared automatically by BX14. Total-4 (Yesterday's total) can be reached only over fieldbus.

[12-] Filter

In this block the proper filter values according to the operating conditions can be entered. One of the most important features of BX series is viewing filter characteristic on the display and with the help of this option, you can select the most suitable filter without exiting the programming mode.

[120 7] Filter

The filter value can be selected from 1 (fastest) to 9 (slowest). Recommended minimum value of the filter is 7 at common weighing applications. As you enter this parameter and press < **Enter** > key while [120 X] seen on the display, the weight variation can be seen on the display. The value of the filter can be changed by using < ↑ > key and the weight variation for every value can be seen on the display. After finishing the filter selection you can go to next step by pressing the < **F** > key.

[14-] Entries

In this block you can enter the date, time and initial CN values.

[140] Date

[DD.MM.YY]

Firstly, press < **Tare** > key for date entrance, then enter the new date via < **Tare** > and < **Zero** > keys and saved by pressing < **Enter** > key.

[141] Time

[HH.MM]

Firstly, press < **Tare** > key for time entrance, then enter the new time via < **Tare** > and < **Zero** > keys and saved by pressing < **Enter** > key.

[142] Label No (CN)

[XXXXXX]

The desired value is entered via < **Tare** > and < **Zero** > keys and saved by pressing < **Enter** > key. If the number exceeds 65535, it will automatically reset and begin from 1 again.

[143 1] Display Refresh Rate

0 : 60ms	1 : 100ms	2 : 200ms	3 : 300ms	4 : 400ms
5 : 500ms	6 : 600ms	7 : 700ms	8 : 800ms	9 : 900ms

[2--] Scale Block

[20-] Set Up

The parameters about weighing operation are being entered here.

[200 0] Approved

- 0 : No. Units of total target ([t-trGt]) and total are displayed 1000 times of the scale division in metric units. OIML's restrictions are not considered.
- 1 : OIML. Units of total target ([t-trGt]) and total are displayed in scale division accuracy. All parameter values are restricted for OIML.
- 2 : No. Units of total target ([t-trGt]) and total are displayed at scale division accuracy. OIML's restrictions are not considered.

[201 0] Increased Indication

- 0 : by pressing key
- 1 : Always increased indication

[203 3] Zeroing Range

- 0 : Disable
- 1 : $\pm 2\%$
- 2 : $\pm 20\%$
- 3 : $\pm 50\%$

[204 0] Auto Zero Tracking

AZT automatically readjusts the scale to zero for compensating selected small deviation per second around centre of zero.

- 0 : Disable
- 1 : $\pm 0,5e$
- 2 : $\pm 1e$

[206 2] Motion Detector

This parameter defines the sensitivity level which will determine what is considered as stable.

- 0 : $\pm 0,3e$
- 1 : $\pm 0,5e$
- 2 : $\pm 1e$
- 3 : $\pm 2e$
- 4 : $\pm 4e$
- 5 : Disable

[21-] Scale Build

The capacity and the resolution of the scale will be defined here.

[212] Capacity

Press < **Tare** > key to reach this parameter.

[CAP]

[XXXXXX]

Enter the capacity of the scale via < **Tare** > and < **Zero** > keys and confirms the value with pressing < **Enter** >.

[d]
[XXXXXX]

Display resolution will be selected by < **Zero** > key and confirmed with < **Enter** > key.

[214 1] Unit

- 0 : kg (Kilogram)
- 1 : lb (Libre)
- 2 : No (without unit)

[3--] Calibration Block

The calibration of the scale will be performed here.

[30-] Calibration

[301] Calibration

Calibration involves emptying the scale then placing a known test weight on an empty scale and allowing the BX14 controller to capture values for zero and span. Calibration is performed as;

1. Press < **Enter** > at the [**301**] prompt to start the calibration.
2. At the [**ZErO.CA**] prompt, remove any weight on the scale, then press < **Enter** >.
3. The terminal automatically starts to capture zero and the [**WArt**] message indicating the operation is in progress.
4. After the [**Load**] prompt, the test weight value will be used for the calibration seen on the display as [**XXXXXX**]. If the value of the test weights that will be used is different from the value shown on the display, type the new value via < **Tare** > and < **Zero** > keys. A minimum of 20% of scale capacity is necessary for calibration; BAYKON recommends 50 to 100%. A calibration error is produced if insufficient weight is used.
5. Place the test weights or another practical weight on the scale.
6. Press < **Enter** > to start span calibration. [**WArt**] message will shown on the display 10 seconds while span calibration is performed.
7. The following parameter is displayed after calibration. If any, error message is announced.
(Page 144)

[302] Linearity Correction

Because of the load cell non linearity or mechanical scale hardware, you may see non linearity on the scale performance. Three step scale calibration in this parameter improves the scale performance.

1. Press < **Enter** > at the [**302**] prompt to start the calibration.
2. At the [**ZErO.CA**] prompt, remove any weight on the scale, then press < **Enter** >.
3. The terminal automatically starts to capture zero and the [**WArt**] message indicating the operation is in progress.
4. At the [**Load 1**] prompt, the test weight value will be used for the first step calibration seen on the display as [**XXXXXX**]. If the value of the test weights that will be used is

- different from the value shown on the display, type the new value via < **Tare** > and < **Zero** > keys. This load value equaling between 35% and 65% of the scale's capacity.
5. Place the test weights or another practical weight on the scale.
 6. Press < **Enter** > to start span calibration. [**WArt**] message will shown on the display 10 seconds while the first span calibration is being performed.
 7. At the [**Load 2**] prompt, the test weight value will be used for the second step calibration seen on the display as [**XXXXXX**]. If the value of the test weights that will be used is different from the value shown on the display, type the new value via < **Tare** > and < **Zero** > keys. Place weight on the scale equaling at least 90% of scale capacity, preferable at scale capacity as much as is practical.
 8. Place the test weights or another practical weight on the scale.
 9. Press < **Enter** > to start second step span calibration. [**WArt**] message will shown on the display 10 seconds while the span calibration is performed.
 10. The following parameter is displayed after calibration. If any, error message is announced.
(Page 144)

[31-] Adjustment

In this sub-block you can only perform zero adjustment or span adjustment without full calibration operation.

[310] Zero Adjustment

This parameter is only being used for refreshing the zero level of the scale to prevent wrong weightings from zero drifts.

1. Press < **Enter** > at the [**310**] prompt to start the zero adjustment.
2. At the [**ZERo.CA**] prompt, remove any weight on the scale, then press < **Enter** >.
3. The terminal automatically starts to capture zero and the [**WArt**] message indicating the operation is in progress.
4. The following parameter is displayed after calibration. If any, error message is announced.
(Page 144)

[311] Span Adjustment

This parameter lets you to perform span adjustment.

1. Press < **Enter** > at the [**311**] prompt to start the span adjustment.
2. At the [**XXXXXX**] prompt, the test weight value will be used for the calibration seen on the display. If the value of the test weights that will be used is different from the value shown on the display, type the new value via tare and zero keys. A minimum of 20% of scale capacity is necessary for calibration; BAYKON recommends 50 to 100%. A calibration error is produced if insufficient weight is used.
3. Place the test weights or another practical weight on the scale.
4. Press < **Enter** > to start span calibration. [**WArt**] message will shown on the display 10 seconds while span calibration is performed.
5. The following parameter is displayed after calibration. If any, error message is announced.
(Page 144)

[312] Span Adjustment Under Load

This parameter is being used to perform span adjustment of a scale without lifting the load on it. This operation especially used for span adjustment for filled tanks. You can make span adjustment without emptying the tank.

1. Press < **Enter** > at the [**312**] prompt to start the span adjustment under load.
2. [**T.Zero**] prompt appears on the display to indicate the scale load will be determined as temporary zero.
3. Press < **Enter** > key and the display will show [**WArt**] message during temporary zero adjustment.
4. At the [**LoAd**] a little while and then [**XXXXXX**] prompt, the test weight value will be used for the calibration seen on the display. If the value of the test weights that will be used is different from the value shown on the display, type the new value via < **Tare** > and < **Zero** > keys.
5. Place the test weights or another practical weight on the scale.
6. Press < **Enter** > to start span calibration. [**WArt**] message will shown on the display 10 seconds while span calibration is performed.
7. The following parameter is displayed after calibration. If any, error message is announced.
(Page 144)

[313] eCal Calibration

Warning: The scale capacity and increment shall be entered before performing eCal.

This parameter lets you to perform calibration without using any test weights. BX14 A/D coefficients are adjusted in production for increasing eCal accuracy. The calibration coefficients are calculated by scale capacity, total load cell capacity, load cell full scale output, and estimated dead load. If the conditions are convenient for zero calibration, you may perform automatic zero adjustment instead of entering estimated preload. Press < **Tare** > key to start eCal.

[LC.CAP]

[XXXXXX]

Enter total load cell capacity via < **Tare** > and < **Zero** > keys and press < **Enter** > key to go to the next step. Example : If the weighing system has 4 pcs 1000 kg load cell, enter 4000.

[LC.oUt]

[XXXXXX]

Enter load cell output in mV/V via < **Tare** > and < **Zero** > keys. If the weighing system has more than one load cell, calculate the mean value of load cells outputs mV/V indicated on the certificates of the load cells. Press < **Enter** > key to go to the next step.

Example: If load cell outputs are LC1: 2.0010, LC2: 1.9998, LC3:1.9986 and LC4:2.0002, the mean value will be

Mean of LC outputs = (2.0010 + 1.9998 + 1.9986 + 2.0002) ÷ 4 = 1.9999 mV/V.

[ZEr.AdJ]

[XXXXXX]

If the scale is empty and you want to make automatic zero adjustment instead of entering estimated dead load (look next step), press < **Enter** > key appears [**Zero.CA**] and press < **Enter** > key for

starting zero calibration. The display will show [**WArt**] message during zero adjustment. In this while the scale must be unloaded and stable. Approximately 10 seconds later eCal calibration is performed.

If the scale is not empty or you prefer to enter estimated preload value, press the < * > key.

[PrE-Ld]

[XXXXXX]

Enter the dead load value of the weighing system in current unit by using < **Tare** > and < **Zero** > keys. Press the < **Enter** > key to go to the next step.

***Note:** If you want to make zero adjustment after entering estimated preload value, empty the scale, change the preload value as (estimated value + display value at empty scale) or enter parameter [**310**] for zero adjustment.*

[32-] Adjustment with Coefficients

In this sub-block you can perform the calibration with entering calibration coefficients, if you noted before.

[320] Zero Coefficient

This coefficient is determined the zero point of the scale. Enter the new value via < **Tare** > and < **Zero** > keys and press < **Enter** > key to go to the next step. You may compensate zero drifts by increasing or decreasing this coefficient.

[321] Test weight Value

The test weight used at the calibration is indicated here. Enter the new value via < **Tare** > and < **Zero** > keys and press < **Enter** > key to go to the next step.

[322 Gain Coefficient

This coefficient is related with the gain factor of the scale. Enter the new value via < **Tare** > and < **Zero** > keys and press < **Enter** > key to go to the next step.

[5--] Filling Block

[50-] Filling Parameters

In this section, the main filling parameters to configure the device are defined.

[501 1] Feeding Type

0 : Coarse and Fine feeding are enabled sequentially

1 : Coarse&Fine and Fine feedings are enabled sequentially

[502 50] Preact Correction Factor

The material flow may change because of temperature, viscosity, the height of the material changes, etc. This causes the filling errors and the fine value is needed to be changed accordingly. BX14 follows the filling errors and adjusts the new preact value for the next filling cycle. The

adjustment rate is defined by this parameter in percent. The new preact value is calculated by the formula below:

$$\text{New fine lead in} = \text{Fine lead in} + \left[\frac{(\text{Actual} - \text{Target}) * \text{Preact Correction Factor}}{100} \right]$$

[504 1.0] Check Delay

Delay time after end of feeding to start stability check.

[505 250] Zeroing Period

[XXXXXX]

This parameter defines the automatic zeroing period in second. The zeroing is performed automatically at the following filling after this time. The value entered here shall be less than the value calculated at the OIML R-61 section A.5.3.5 for approved usage. If the zeroing will be done each filling, this value shall be entered less than minimum filling time. Maximum value is 5399 sec (90 minutes).

[506 2.0] Zeroing Delay

This parameter defines the zeroing delay time before zeroing. Maximum value is 9.9 seconds.

[507 0] Indication at the End of Filling

- 0 : The last filling value and [**FuLL**] message toggles at the end of the filling.
- 1 : Actual value and [**FuLL**] message toggles at the end of the filling.
- 2 : Target value and [**FuLL**] message toggles at the end of the filling.

[508 100] Feeding Check Time

[XXXXXX]

This parameter defines feeding check time in second. If there is no material flow within this period, [**no FEEd**] message is displayed and ton/hour value is zeroed. Entry can be between 010 to 599 sec (10 minutes).

***Warning:** In this case, BX14 waits for a resumption of the flow of material without changing the status of the feed outputs.*

[509 999999] Maximum Filling Weight

[XXXXXX]

This parameter limits the maximum Target value entry.

[8--] Metrological Data Block

The parameters about Metrologic Registry are being entered in this section.

[80-] Legal Metrologic Records

[800] Counter

This counter increases by 1 automatically after entering the programming mode with calibration jumper and service password. This counter cannot be changed manually.

[9--] Diagnostics

The operations about checking and testing BX14 can be made here.

[90-] Tests

[900] Key Pad testing

In this step every keys ASCII code will be shown on the display as you press the related key. By this way you can test if all the keys are functional or not. Pressing < ↑ > key will take you to the next parameter.

[901] RS 232C Serial Interface testing

The characters in the alphabet will sequentially be transferred from RS 232C serial interface port by pressing < **Zero** > key one after another. Received numerical data is seen on display.

[902] RS 485 Serial Interface testing

The characters in the alphabet will sequentially be transferred from RS 485 serial interface port by pressing < **Zero** > key one after another. Received numerical data is seen on display.

[903] Parallel Inputs

[i X Y]

To perform parallel input test, enter the number of parallel input to Y digits via < **Zero** > key. X shows the logical condition of that input.

[904] Parallel Outputs

[o X Y]

To perform parallel output test, enter the number of parallel output to Y digits via < **Zero** > key. To change the logical condition of that output via < **Tare** > key and X shows the logical condition of that output.

[905] mV Indication

As you press < **Enter** > key the output voltage of the load cell will be shown on the display. This uncalibrated value is only for test / service purposes.

[91-] Firmware Information

[910] Version of Option Board

[XX.YY]

The format of the version is XX.YY. XX digits are major version number and YY digits are minor version number for firmware changing.

[92-] Log Book

[920] Error history

[Err XX]

The last 20 errors listed in this parameter. Press < * > key to access the previous error log.

[921] Setup history

[SERVICE]

The last 20 service entry listed in this parameter. Press < * > key to access the previous entry log.

[99-] Printing Parameter Values

[990] Print All Parameters

By pressing < **Enter** > key the whole parameters can be printed.

[991] Load Default

Press < **Enter** > key. [**Ld dEf**] message appears on the display. Press < **Tare** > key for loading default parameter values or press < **F** > key to go [**9-**] sub block.

The scale build parameters and calibration is not changed.

9. MODBUS RTU

BX14 controller has a Modbus RTU interface over RS485 / RS232C serial port. This interface can be programmable to High-Low or Low-High for different type of PLC's. You can find below the difference of these data formats and some companies using these formats. Two types are available as;

9.1 Modbus RTU Data Structure

After programming RS485 / RS232C serial port for Modbus RTU, it can be used as a Modbus RTU slave on Modbus RTU network. The Modbus slave address is defined in the RS-485 address (*Page 48*). Functions code '0x03' (Read Holding Registers), '0x06' (Single Write Register), '0x10' (Preset Multiple Registers) and '0x17' (Read/Write Multiple Registers) are supported.

Modbus RTU High-Low: In two word registers, the data is stored to the registers in big-endian format. Least significant word is stored to the highest register address; and most significant word is stored to the lowest register address.

Modbus RTU Low-High: In two word registers, the data is stored to the registers in little-endian format. Least significant word is stored to the lowest register address; and most significant word is stored to the highest register address.

Parameter's set-up:

Set the RS 485 / RS 232C Data Format : Modbus RTU High-Low or Modbus RTU Low-High

RS-485 Data Length & Parity : 8 none 1, 8 odd 1 or 8 even 1

RS-485 Address : 01 to 31

Make the RS-485 / RS 232C parameter settings as defined on *Page 47*.

Please find Modbus information in the web site of <http://www.modbus.org>

Modbus RTU Command Table;

Address	R/W	Word	Command	Definition			
40001	R	2	Actual weight (Net if the indication is in Net)				
40003	R	1	Status	Bit	Description		
				D0	0 – System Ready	1 – System Busy	
				D1	0 – Error (D13-D15)	1 – Data ok	
				D2	0 – Weight Stable	1 – Weight unstable	
				D3	0 – Gross Mode	1 – Net mode	
				D4	Not used		
				D5	0 - No process error	1 – Process error (refer to 40113)	
				D6 – D11	Not used		
				D12	0 – Out of zero range	1 – Weight is in zero range	
				D13	Error Code	Dec	Description
				D14		0	No Errors
				D15		1	ADC out of range
						2	ADC over range
	3	ADC under range					
	4	System error					
	5	In programming mode					
	6	Low/High voltage det.					

40004	R	2	Tare weight			
40006	R	2	Gross weight			
40008	R	1	Status	Motion, Net mode, Data ok, (image of register 40003)		
40009	R/W	1	Control	Dec	Description	
				0	None	
				1	Zero	
				2	Tare	
				3	Clear	
				4	Print	
				8	Start for filling	
				9	Reset	
				14	Start for emptying	
				15	By-Pass function enable	
16	By-Pass function disable					
40010	R/W	1	Not used			
40011	R/W	2	Target value	Refer to page 38		
40013	R/W	2	Not used			
40015	R/W	2	Coarse value	Refer to page 38		
40017	R/W	2	Fine value	Refer to page 38		
40019	R/W	1	CN (Label number)	Refer to parameter [142] on page 53		
40020	R	2	Last filling value			
40022	R/W	1	Quantity			
40023	R/W	2	Total-1	Erasable total		
40025	R	1	Digital inputs status	Bit	Description	0 - Passive 1 - Active
				D0	Input-1	
				D1	Input-2	
				D2	Input-3	
				D3	Input-4	
				D4	Not used	
				D5	Not used	
				D6	Pipe is clogged	
D7	By-Pass					
40026	R	2	Digital outputs status	D0	Output-1	0 - Passive 1 - Active
				D1	Output-2	
				D2	Output-3	
				D3	Output-4	
				D4	Output-5	
40028	R/W	2	Not used			
40030	R/W	1	Calibration	Dec	Description	
				0	None	
				188	Adjust Zero Calibration	
				220	Adjust Span Calibration ⁽¹⁾	

				236	Total Load Cell Capacity ⁽¹⁾	eCal Coefficients	
				250	Average mV/V ⁽¹⁾		
				171	Dead Load ⁽¹⁾		
				23205	Save the coefficients of eCal		
40031	R/W	2	Span Calibration Value / LC capacity / mV value / Dead load value				
40033	R	1	Calibration Status	D0 .. D7	Dec	Description	
					1	Ready for calibration	
					3	Zero calibration in process ...	
					4	Span calibration in process ...	
				D8 .. D15	Calibration Errors	9	Error (Refer to D8 ... D15)
						1	Calibration Timeout - Restart calibration
						2	ADC Error - Re-energize the instrument - If seen again, change the board.
						3	Instrument cannot be calibrating - Check load cell cable - Re-energize the instrument
						34	Instrument cannot be calibrating - Load cell signal is very low or too high
						35	Calibration Error - Calibration loading is not enough - Check test weight loading or LC connections
						36	Calibration load value entry Error - Test weight is too small. Increase the weight
						37	Scale unstable - Wait until scale become stable - Check grounding wiring
38	The Calibration DIP switch is not 'On' position. - Check the calibration DIP switch.						
40034	R/W	6	Not used				
Application Parameters							
40040	R/W	2	D_DISC	End of emptying delay			
40042	R/W	2	D_GATE	Gate control delay			
40044	R/W	2	ZERO_R	Zero range			
40046	R/W	2	T_TRGT	Total target			
40048	R/W	2	TON_HR	Flow rate			
40050	R/W	2	S_QTY	Sampling Quantity			
40052	R/W	2	GAT_CH	Gate position check			
40054	R/W	17	Not used				
40071	R	1	Actual weight	(image of register 40001)			
40072	R	1	Status	(image of register 40003)			
40073	R	1	Tare weight	(image of register 40004)			
40074	R	1	Gross weight	(image of register 40006)			

40100	R	1	Voltage of Power Supply	Voltage of power supply is indicated with 0.1 V increment. For example: 23.4 VDC is indicated as integer 234 value.	
40101	R	2	Ton/hour indication	The actual flow rate	
40103	R	2	24 hours indication	Estimated daily total	
40105	R/W	2	Total-1	Erasable total (Image of register 40023)	
40107	R	2	Total-2	The current day's total	
40109	R	2	Total-4	Yesterday's total	
40111	R	2	Total-3	Non-erasable total	
40113	R	1	Process Warning Messages	Dec	Description
				0	No process error
				1	END
				2	BY-PASS
				3	NO FEED
			Process Error Messages	4	RESET
				128	E GATE
				129-135	Not used
			136	E FEED	
40114	R	1	Process state	0	No process (Adc out, Over, Under etc.)
				1	Ready
				2	In filling process
				3	End of filling (FULL)
				4	In discharging process
				5	Delay of flow rate control ([d_tonh] message)
42000	R/W	1	Filter	Refer to parameter [120] on page 53	
42001	R/W	1	Not used		
42002	R/W	1	Zeroing Range	Refer to parameter [203] on page 54	
42003	R/W	1	Auto Zero Tracking	Refer to parameter [204] on page 54	
42004	R/W	1	Not used		
42005	R/W	1	Motion Detector	Refer to parameter [206] on page 54	
42006	R/W	2	Not used		
42008	R/W	2	Capacity	Refer to parameter [212] on page 54	
42010	R/W	1	Decimal point	Dec	Description
				0	XXXX00
				1	XXXXX0
				2	XXXXXX
				3	XXXXX.X
				4	XXXX.XX
5	XXX.XXX				
42011	R/W	1	Increment	Dec	Description
				1	X 1
				2	X 2
				3	X 5

42101	R/W	1	Feeding type	Refer to parameter [501] on page 58
42102	R/W	1	Preact correction factor	Refer to parameter [502] on page 58
42103	R/W	1	Not used	
42104	R/W	1	Check delay	Refer to parameter [504] on page 59
42105	R/W	1	Zeroing period	Refer to parameter [505] on page 59
42106	R/W	1	Zeroing delay	Refer to parameter [506] on page 59
42107	R/W	1	Indication at the end of filling	Refer to parameter [507] on page 59
42108	R/W	1	Feeding check time	Refer to parameter [508] on page 59
42109	R/W	2	Maximum filling weight	Refer to parameter [509] on page 59

(1) Write this command after writing values to 40031-32 addresses.

Programming steps of frequent used

Reading a weight value:

1. Read 40003 (or 40008, 40073),
2. Check D0=0, D1=1 and D5=0,
3. If yes, read a weight value (gross, net or tare),
4. If D0=1, check D0 until system ready,
5. If D1=0, check the error code or if D5=1, check the process error messages from 40105.

Zero Calibration procedure:

1. Check the low byte of 40033. it should be decimal '1' to start adjustment.
2. Load the decimal '188' to 40030 to start Zero calibration.
3. Check the low byte of 40033. it is decimal '3' during zero calibration process.
4. The low byte of 40033 changes to decimal '1' at the end of the Zero calibration.
5. If the low byte of 40033 is '9', check the high byte of 40033 to understand the calibration error.

Span Calibration procedure:

1. Check the low byte of 40033. it should be decimal '1' to start adjustment.
2. First load the span value to 40031-32 and then load the decimal '220' to 40030 to start Span calibration.
3. Check the low byte of 40033. it is decimal '4' during span calibration process.
4. The low byte of 40033 changes to decimal '1' at the end of the Span calibration.
5. If the low byte of 40033 is '9', check the high byte of 40033 to understand the calibration error.

EXPLANATION:

Attention: For hardware connection details, please refer to the related hardware descriptions in this manual.

Exception codes:

- 1: Function code is not supported.
- 2: Out of beginning and ending address range.
- 3: Invalid value entrance or wrong byte number.
- 4: Operation error.

Command Examples:

Performing Read and Write operations according (Modbus RTU High-Low) to hex system with the instrument set to address "0x01".

Below you will find some command samples;

Description	Hex
Request weight data	01,03,00,00,00,02,C4,0B
Answer of request weight (weight value is 100000)	01,03,04,00,01,86,A0,38,4A
Request status data	01,03,00,02,00,01,25,CA
"Start for filling" Command	01,10,00,08,00,01,02,00,08,A6,DE
"Start for emptying" Command	01,10,00,08,00,01,02,00,0E,26,DC
"Reset" Command	01,10,00,08,00,01,02,00,09,67,1E
Zero Command	01,10,00,08,00,01,02,00,01,66,D8
Read digital inputs	01,03,00,C7,00,01,35,F7
Answer of digital inputs (Input-2 is active)	01,03,02,00,02,39,85
Read digital outputs	01,03,00,C8,00,01,05,F4
Answer of digital outputs (Output-3 is Active)	01,03,02,00,04,B9,87
Request Calibration Status	01,03,00,20,00,01,85,C0
Answer of request Calibration Status (Instrument is ready for calibration)	01,03,02,00,01,79,84
Zero Calibration	01,10,00,1D,00,01,02,00,BC,A4,6C
Span Calibration Command with Span value 50000	01,10,00,1D,00,03,06,00,DC,00,00,C3,50,F7,F0
Total LC capacity Command with Total LC capacity value 100000	01,10,00,1D,00,03,06,00,EC,00,01,86,A0,D4,E0
Average mV/V Command with Average mV/V value 1.9999	01,10,00,1D,00,03,06,00,FA,00,00,4E,1F,DA,93
Dead load Command with Dead load value 12345	01,10,00,1D,00,03,06,00,AB,00,00,30,39,87,25
Save the coefficients of eCal Command	01,10,00,1D,00,01,02,5A,A5,5F,06
Read Voltage of Power Supply value	01,03,00,63,00,01,74,14
Answer of Voltage of Power Supply (Voltage of Power Supply is 23,5 V)	01,03,02,00,EB,F8,0B

Example of a program:

PLC application files are available in CD which is supplied together with the instrument.

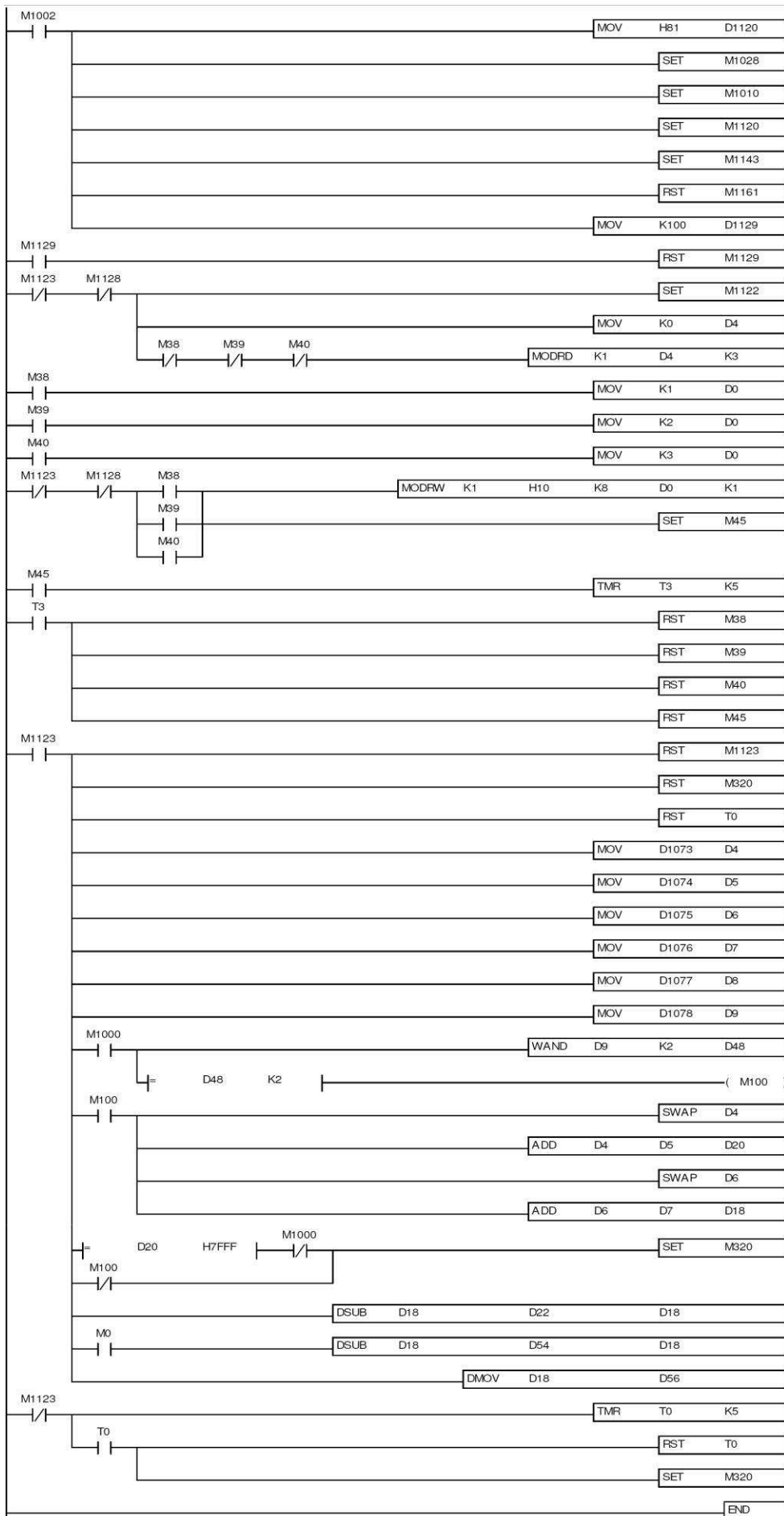

10. PROFIBUS (ONLY BX14 PB)

In Profibus DPV1 interface, baud rate is detected automatically. Supported baud rates are 9.6 kbps, 19.2 kbps, 45.45 kbps, 93.75 kbps, 187.5 kbps, 500 kbps, 1.5 Mbps, 3 Mbps, 6 Mbps and 12 Mbps. No 'baud rate' instance exists.

After programming Profibus related parameters of the BX14 PB controller, you can communicate with the instrument. GSD file is available in CD which is supplied together with the instrument.

There are two LED's near the Profibus connector which are ;

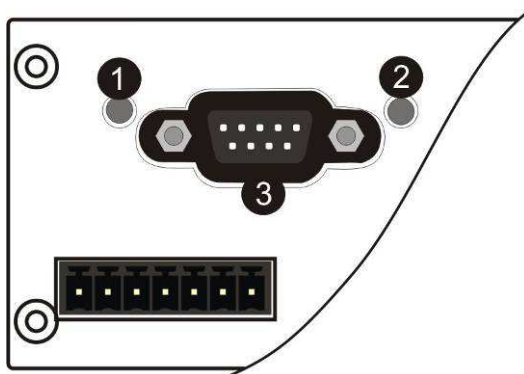

1	OP Operation mode LED
2	ST Status LED
3	Profibus Connector

OP Operation mode LED

State	Indication	Comment
Off	Not online /No power	Check power and cable
Green	On-line, data exchange	-
Flashing Green	On-line, clear	-
Flashing Red (2 flash)	PROFIBUS configuration error	Check GSD file configuration.

ST Status LED

State	Indication	Comment
Off	Not power or not initialized	No power or profibus module is in initialization state
Green	Initialized	
Flashing Green	Initialized, diagnostic event(s) present	Diagnostic is active
Red	Exception error	There is an exception error

10.1 Data Format

Data format of weight value can be programmable for Floating point (IEEE 754) or Integer. Refer to parameter [050].

10.2 GSD Configuration

Profibus data is consist of 2 x Input 2 words and 2 x Output 2 words. GSD configuration for PLC programmers is shown in Figure 10-1.

Steckplatz	DP-Kennung	Bestellnummer / Bezeichnung	E-Adresse	A-Adresse	Kommentar
1	209	Input 2 words	50..53		
2	209	Input 2 words	54..57		
3	225	Output 2 words		50..53	
4	225	Output 2 words		54..57	
5					
6					
7					
8					
9					
10					
11					
12					
13					
14					
15					
16					

Figure 10-1 - GSD Configuration

GSD Configuration	Description
Input 2 words	1 st Dword (BX14 PB Output to PLC Input)
Input 2 words	2 nd Dword (BX14 PB Output to PLC Input)
Output 2 words	1 st Dword (PLC Output to BX14 PB Input)
Output 2 words	2 nd Dword (PLC Output to BX14 PB Input)

10.3 Profibus DP Data Structure

BX14 PB Output to PLC Input

Bitwise of a Dword:

Dword (Only read)	D31	D30	D29	D28	D27	D26	D25	D24	D23	D22	D21	D20	D19	D18	D17	D16
	D15	D14	D13	D12	D11	D10	D9	D8	D7	D6	D5	D4	D3	D2	D1	D0

1 st Dword	By default, Actual weight value is represented. To represent other weight or calibration status, refer to next Dword.															
2 nd Dword				Out 5	Out 4	Out 3	Out 2	Out 1	By- Pass	Pipe is clog.			In 4	In 3	In 2	In 1
	Error codes of BX14 PB					Process Error		Centre of zero	Gross Net	MD	Read command response					Cmd Flg

BX14 PB Output to PLC Input 2nd Dword

Bit Number	2 nd Dword Description			
D31 ... D24	Outputs	Output bit status (Active = 1)		
D23 ... D16	Inputs	Input bit status (Active = 1)		
D15 ... D12	Error Codes of BX14 PB	Bin	Dec	Descriptions
		0000	0	No error found
		0001	1	ADC out
		0010	2	ADC over
		0011	3	ADC under
		0100	4	System Error
		0101	5	In programming mode
		0110	6	Low/High Voltage Error
D11	Not in use			
D10	Process Error	0	No error	
		1	Process error (Check the 'Process error messages')	
D9	Not in use			
D8	Centre of zero	0	Weight is out of zero range	
		1	Weight is in zero range	
D7	Indication	0	Gross	
		1	Net	
D6	MD – Motion Detection	0	Stable	
		1	Dynamic	
D5 ... D1	Read Command Response	00000	0	Actual weight (Net if the indication is in Net)
		00001	1	Gross weight
		00010	2	Tare weight
		00011	3	Calibration Status (Refer to Table 10-2)
		00100	4	Not used
		01110	14	

D5 ... D1	Read Command Response (continuation of previous page)	01111	15	Total-3 (Non-erasable total)
		10000	16	Not used
		10001	17	Target value
		10010	18	Not used
		10011	19	Coarse value
		10100	20	Not used
		10101	21	Fine value
		10110	22	Label number (CN) (Always integer)
		10111	23	Last filling value
		11000	24	Quantity (Always integer)
		11001	25	Total-1 (Erasable total)
		11010	26	Total-2 (The current day's total)
		11011	27	Total-4 (Yesterday's total)
		11100	28	Ton / hour indication (The actual flow rate)
		11101	29	24 hours indication (Estimated daily total)
11110	30	Process error messages (Refer to Table 10-1)		
	11111	31	Use the Expanded Command list (Refer to Table 10-3)	
D0	CMD Flag	Toggles	The command is applied successfully	

Process error messages (always 32 bit integer)

1st Dword descriptions when read command is 'Process error messages'. Refer to 2nd Dword of PLC Output to BX14 PB Input

Bit Number	1 st Dword Description			
D31 ... D16	Not in use			
D15 ... D8	Process State	Bin	Dec	Process state
		00000000	0	No process (Adc out, Over, Under etc.)
		00000001	1	Ready
		00000010	2	In filling process
		00000011	3	End of filling (FULL)
		00000100	4	In discharging process
		00000101	5	Delay of flow rate control ([d_tonh] message)
D7 ... D0	Process warning Messages	Bin	Dec	Messages
		00000000	0	No process error
		00000001	1	END
		00000010	2	BY-PASS
		00000011	3	NO FEED
	Process error Messages	00000100	4	RESET
		10000000	128	E GATE
		10000001	129	Not used
		10000111	135	
	10001000	136	E FEED	

Table 10-1– Process error messages

Calibration Status (always 32 bit integer)

1st Dword descriptions when read command is 'Calibration Status'. Refer to 2nd Dword of PLC Output to BX14 PB Input

Bit Number	1 st Dword Description			
D31 ... D16	Not in use			
D15 ... D8	Calibration Errors	Bin	Dec	Commands
		0000 0001	1	Calibration Timeout - Restart calibration
		0000 0010	2	ADC Error - Re-energize the instrument
		0000 0011	3	Instrument cannot be calibrating - Check load cell cable - Re-energize the instrument
		0010 0010	34	Instrument cannot be calibrating - Load cell signal is very low or too high
		0010 0011	35	Calibration Error - Calibration loading is not enough - Check test weight loading (Write test weight value to 1 st Dword of PLC Output to BX14 PB Input then restart the calibration) - Check load cell connections
		0010 0100	36	Calibration load value entry Error - Test weight is too small. Increase the test weight
		0010 0101	37	Scale unstable - Wait until scale become stable - Check grounding wiring
		0010 0110	38	The Calibration DIP switch is not 'On' position. - Check the calibration DIP switch.
D7 ... D0	Calibration Process Status	0000 0001	1	System ready for calibration
		0000 0011	3	Zero calibration in process
		0000 0100	4	Span calibration in process
		0000 1001	9	Error (Refer to Calibration Errors)

Table 10-2 - Calibration status

PLC Output to BX14 PB Input

Bitwise of a Dword:

Dword (R/W)	D31	D30	D29	D28	D27	D26	D25	D24	D23	D22	D21	D20	D19	D18	D17	D16
	D15	D14	D13	D12	D11	D10	D9	D8	D7	D6	D5	D4	D3	D2	D1	D0

1 st Dword	Next Dword defines the usage of this Dword.																
2 nd Dword	SFE		Reset	Filling Start	BY- PASS	Not in use		Expanded Commands List									
	Not in use				Command List				Read Data Selection				New CMD				

PLC Output to BX14 PB Input 2nd Dword

Bit Number	2 nd Dword descriptions					
D31 ... D30	Not used					
D29	Start for emptying (SFE)		A transition from 0 to 1 activates the "Start for emptying" command.			
D28	Reset		A transition from 0 to 1 activates the "Reset" command.			
D27	Start for filling		A transition from 0 to 1 activates the "Start for filling" command.			
D26	By-Pass		A transition from 0 to 1 activates the by-pass function and transition from 1 to 0 deactivates the by-pass function.			
D25 ... D24	Not used					
D23 ... D16	Expanded Commands List (Refer to Table 10-3)					
D15 ... D11	Not in use					
D10 ... D6	Command List	Bin	Dec	Commands		
		00000	0	None command is activated		
		00001	1	Zero		
		00010	2	Tare		
		00011	3	Clear		
		00100	4	Print		
		00101	5	Adjust zero calibration		Calibration
		00110	6	Adjust span calibration ⁽¹⁾		
		00111	7	Total Load Cell Capacity ⁽¹⁾		eCal Coefficients
		01000	8	Average mV/V value ⁽¹⁾		
		01001	9	Dead Load value ⁽¹⁾		
01010	10	Save the coefficients of eCal				
					<i>Refer to par. [313]</i>	

D10 ... D6	Command List (continuation of previous page)	01011	11	Not used
		10000	16	
		10001	17	Target value ^[1]
		10010	18	Not used
		10011	19	Coarse value ^[1]
		10100	20	Not used
		10101	21	Fine value ^[1]
		10110	22	Label number (CN) (Always integer) ^[1]
		10111	23	Not used
		11000	24	Quantity (Always integer) ^[1]
		11001	25	Total-1 ^[1] (Erasable total)
		11010	26	Not used
		11110	30	
11111	31	Use the Expanded Command list (Refer to Table 10-3)		
D5 ... D1	Read Selection Data	00000	0	Actual weight (Net if the indication is in Net)
		00001	1	Gross weight
		00010	2	Tare weight
		00011	3	Calibration Status (Refer to Table 10-2)
		00100	4	Not used
		01110	14	
		01111	15	Total-3 (Non-erasable total)
		10000	16	Not used
		10001	17	Target value
		10010	18	Not used
		10011	19	Coarse value
		10100	20	Not used
		10101	21	Fine value
		10110	22	Label number (CN) (Always integer)
		10111	23	Last filling value
		11000	24	Quantity (Always integer)
		11001	25	Total-1 (Erasable total)
		11010	26	Total-2 (The current day's total)
		11011	27	Total-4 (Yesterday's total)
		11100	28	Ton / hour indication (The actual flow rate)
11101	29	24 hours indication (Estimated daily total)		
11110	30	Process error messages (Refer to Table 10-1)		
11111	31	Use the Expanded Command list (Refer to Table 10-3)		
D0	New CMD	Toggle		Apply commands which are listed in this table

(1) Write this command after writing values to 1st Dword, then apply this command with New CMD

Expanded Command List (always 32 bit integer)

Here 1st Dword is the data receiving from PLC and the “D23 ... D16” bits describes below.

Bit No	Description						
D23...D16	Expanded Commands List	Binary	Dec	R/W	Commands		
		00000000	0	R	Voltage of Power Supply	Voltage of power supply is indicated with 0.1 VDC increment.	
		00000001 00011111	1 31	Not in use			
					Application Parameters ⁽¹⁾		
		00100000	32	R/W	D_DISC	End of emptying delay	
		00100001	33	R/W	D_GATE	Gate control delay	
		00100010	34	R/W	ZERO_R	Zero range	
		00100011	35	R/W	T_TRGT	Total target	
		00100100	36	R/W	TON_HR	Flow rate	
		00100101	37	R/W	S_QTY	Sampling Quantity	
		00100110	38	R/W	GAT_CH	Gate position check	
		00100111 00111111	39 63	Not used			
		01000000	64	R/W	Filter ⁽¹⁾	Refer to par. [120] on page 53	
		01000001	65	Not used			
		01000010	66	R/W	Zeroing Range ⁽¹⁾	Refer to par. [203] on page 54	
		01000011	67	R/W	Auto Zero Tracking ⁽¹⁾	Refer to par. [204] on page 54	
		01000100	68	Not used			
		01000101	69	R/W	Motion Detector ⁽¹⁾	Refer to par. [206] on page 54	
		01000110 01000111	70 71	Not used			
		01001000	72	R/W	Capacity ⁽¹⁾	Refer to par. [212] on page 54	
		01001001	73	R/W	Decimal point ⁽¹⁾	0	XXXX00
						1	XXXXX0
						2	XXXXXX
						3	XXXXX.X
						4	XXXX.XX
						5	XXX.XXX
		01001010	74	R/W	Increment ⁽¹⁾	1	X1
						2	X2
						3	X5
		01001011 01100000	75 96	Not Used			
		01100001	97	R/W	Feeding type ⁽¹⁾	Refer to par. [501] on page 58	
		01100010	98	R/W	Preact correction factor ⁽¹⁾	Refer to par. [502] on page 58	
01100011	99	R/W	Not used				
01100100	100	R/W	Check delay ⁽¹⁾	Refer to par. [504] on page 59			
01100101	101	R/W	Zeroing period ⁽¹⁾	Refer to par. [505] on page 59			
01100110	102	R/W	Zeroing delay ⁽¹⁾	Refer to par. [506] on page 59			
01100111	103	R/W	Ind. at the end of filling ⁽¹⁾	Refer to par. [507] on page 59			
01101000	104	R/W	Feeding check time ⁽¹⁾	Refer to par. [508] on page 59			
01101001	105	R/W	Maximum filling weight ⁽¹⁾	Refer to par. [509] on page 59			

Table 10-3 - Expanded Command List

(1) Write this command after writing values to 1st Dword then apply this command with New CMD.

Programming steps of frequent used

Reading a weight value:

1. Check the D11...D15 bits of 'BX14 PB Output to PLC Input 2nd Dword'.
2. If there is not any error, read a weight value (gross, net or tare),

Zero Calibration procedure:

1. Check the low byte of Calibration Status. it should be decimal '1' to start adjustment.
2. Write 'Adjust Zero Calibration' command and apply New CMD to start Zero calibration.
3. Check the low byte of Calibration Status. it is decimal '3' during zero calibration process.
4. The low byte of Calibration Status changes to decimal '1' at the end of the Zero calibration.
5. If the low byte of Calibration Status is '9', check the high byte of Calibration Status to understand the calibration error.

Span Calibration procedure:

1. Check the low byte of Calibration Status. it should be decimal '1' to start adjustment.
2. Write 'Adjust Span Calibration' command after writing test weight values to 1st Dword, then apply this command with New CMD to start Span calibration.
3. Check the low byte of Calibration Status. it is decimal '4' during span calibration process.
4. The low byte of Calibration Status changes to decimal '1' at the end of the Span calibration.
5. If the low byte of Calibration Status is '9', check the high byte of Calibration Status to understand the calibration error.

11. PROFINET (ONLY BX14 PN)

Profinet interface of the weighing instrument can be done via hub switch or serial bus over two Profinet port.

1. Serial bus connection of instruments. You may connect instruments serial to your Profinet bus via two ports.
2. Star connection. If you connect the instrument to your PLC via hub switch, you can use P1 or P2 port on the instrument. You may change the port, if there is any malfunction on port in usage.

The Profinet interface is 100Mbit and full duplex. GSDML file for two port Profinet is available in CD which is supplied together with the instrument.

There are 4 announcement LEDs on the instrument to indicate the interface status as seen below. The meanings of these LED's are;

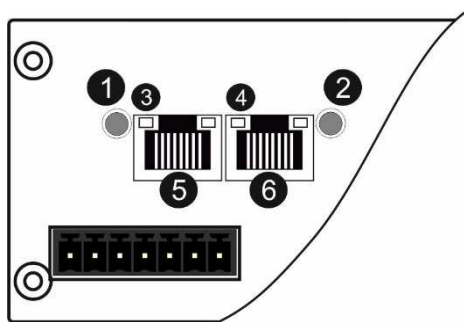

1	NS Network Status LED
2	MS Module Status LED
3	Link/Activity LED (port 1)
4	Link/Activity LED (port 2)
5	P1 Profinet interface (port 1)
6	P2 Profinet interface (port2)

NS Network Status LED

LED State	Description	Comment
Off	Not online /No power	Check power and cable
Green	On-line RUN	-
Green, flashing	On-line STOP	-

MS Module Status LED

LED State	Description	Comment
Off	Not power or not initialized	No power or Profinet module is in initialization state
Green	Normal operation	
Green, 1 flash	Initialized, diagnostic event(s) present	Diagnostic is active
Red	Exception error	There is an exception error
Red, 1 flash	Configuration Error	Check GSDML configuration
Red, 2 flashes	IP Address Error	IP address not set
Red, 3 flashes	Device Name Error	Device name not set
Red, 4 flashes	Internal Module Error	Re-energize the instrument. If seen again, change the board.

In the case of red LED warning, check cabling, configuration, IP address and device name before reenergizing the instrument after 30 seconds power off.

LINK/Activity LED

LED State	Description	Comment
Off	No Link	No link, no communication present
Green	Link	Ethernet link established, no communication present
Green, flickering	Activity	Ethernet link established, communication present

11.1 Data Format

Data format of weight value can be programmable for Floating point (IEEE 754) or Integer. Refer to parameter [060].

11.2 Profinet Parameters

There are 7 parameters for Profinet network and Profinet set up is done by EtherX PC software over Local Network Area as described in this section. EtherX PC software is available in CD which is supplied together with the instrument.

Note: Station name is 'pn-io' as a default.

DHCP

Dynamic Host Configuration Protocol automates network parameters if it is enabled.

Default is 'Disable'.

IP Address

If DHCP is disabled, obtain IP address manually.

Default is '192.168.16.250'.

Subnet Mask

If DHCP is disabled, obtain subnet mask manually.

Default is '255.255.255.0'.

Default Gateway

If DHCP is disabled, obtain default gateway manually.

Default is '192.168.16.253'.

Primary DNS

If DHCP is disabled, obtain primary DNS manually.

Default is '208.67.222.222'.

Secondary DNS

If DHCP is disabled, obtain secondary DNS manually.

Default is '208.67.220.220'.

Host Name

Enter a unique host name to the instrument.

Default is ' '.

11.3 GSDML Configuration

Profinet data structures of BX14 PN include 2 x Input 2 words and 2 x Output 2 words. GSDML configuration for PLC programmers is shown in Figure 11-1.

Steckplatz	DP-Kennung	Bestellnummer / Bezeichnung	E-Adresse	A-Adresse	Kommentar
1	209	Input 2 words	50..53		
2	209	Input 2 words	54..57		
3	225	Output 2 words		50..53	
4	225	Output 2 words		54..57	
5					
6					
7					
8					
9					
10					
11					
12					
13					
14					
15					
16					

Figure 11-1 - GSDML Configuration

GSDML Configuration	Description
Input 2 words	1 st Dword (BX14 PN Output to PLC Input)
Input 2 words	2 nd Dword (BX14 PN Output to PLC Input)
Output 2 words	1 st Dword (PLC Output to BX14 PN Input)
Output 2 words	2 nd Dword (PLC Output to BX14 PN Input)

11.4 Profinet Data Structure

BX14 PN Output to PLC Input

Bitwise of a Dword:

Dword (Only read)	D31	D30	D29	D28	D27	D26	D25	D24	D23	D22	D21	D20	D19	D18	D17	D16
	D15	D14	D13	D12	D11	D10	D9	D8	D7	D6	D5	D4	D3	D2	D1	D0

1 st Dword	By default, Actual weight value is represented. To represent other weight or calibration status, refer to next Dword.															
2 nd Dword				Out 5	Out 4	Out 3	Out 2	Out 1	By- Pass	Pipe is clog.			In 4	In 3	In 2	In 1
	Error codes of BX14 PN					Process Error		Centre of zero	Gross Net	MD	Read command response					Cmd Flg

BX14 PN Output to PLC Input 2nd Dword

Bit Number	2 nd Dword Description			
D31 ... D24	Outputs	Output bit status (Active = 1)		
D23 ... D16	Inputs	Input bit status (Active = 1)		
D15 ... D12	Error Codes of BX14 PN	Bin	Dec	Descriptions
		0000	0	No error found
		0001	1	ADC out
		0010	2	ADC over
		0011	3	ADC under
		0100	4	System Error
		0101	5	In programming mode
		0110	6	Low/High Voltage Error
D11	Not in use			
D10	Process Error	0	No error	
		1	Process error (Check the 'Process error messages')	
D9	Not in use			
D8	Centre of zero	0	Weight is out of zero range	
		1	Weight is in zero range	
D7	Indication	0	Gross	
		1	Net	
D6	MD – Motion Detection	0	Stable	
		1	Dynamic	
D5 ... D1	Read Command Response	00000	0	Actual weight (Net if the indication is in Net)
		00001	1	Gross weight
		00010	2	Tare weight
		00011	3	Calibration Status (Refer to Table 11-2)
		00100	4	Not used
		01110	14	

D5 ... D1	Read Command Response (continuation of previous page)	01111	15	Total-3	(Non-erasable total)
		10000	16	Not used	
		10001	17	Target value	
		10010	18	Not used	
		10011	19	Coarse value	
		10100	20	Not used	
		10101	21	Fine value	
		10110	22	Label number (CN)	(Always integer)
		10111	23	Last filling value	
		11000	24	Quantity	(Always integer)
		11001	25	Total-1	(Erasable total)
		11010	26	Total-2	(The current day's total)
		11011	27	Total-4	(Yesterday's total)
		11100	28	Ton / hour indication	(The actual flow rate)
		11101	29	24 hours indication	(Estimated daily total)
11110	30	Process error messages	(Refer to Table 11-1)		
11111	31	Use the Expanded Command list (Refer to Table 11-3)			
D0	CMD Flag	Toggles		The command is applied successfully	

Process error messages (always 32 bit integer)

1st Dword descriptions when read command is 'Process error messages'. Refer to 2nd Dword of PLC Output to BX14 PN Input

Bit Number	1 st Dword Description			
D31 ... D16	Not in use			
D15 ... D8	Process State	Bin	Dec	Process state
		00000000	0	No process (Adc out, Over, Under etc.)
		00000001	1	Ready
		00000010	2	In filling process
		00000011	3	End of filling (FULL)
		00000100	4	In discharging process
		00000101	5	Delay of flow rate control ([d_tonh] message)
D7 ... D0	Process warning Messages	Bin	Dec	Messages
		00000000	0	No process error
		00000001	1	END
		00000010	2	BY-PASS
		00000011	3	NO FEED
	00000100	4	RESET	
	Process error Messages	10000000	128	E GATE
		10000001	129	Not used
		10000111	135	
10001000		136	E FEED	

Table 11-1– Process error messages

Calibration Status (always 32 bit integer)

1st Dword descriptions when read command is 'Calibration Status'. Refer to 2nd Dword of PLC Output to BX14 PN Input

Bit Number	1 st Dword Description			
D31 ... D16	Not in use			
D15 ... D8	Calibration Errors	Bin	Dec	Commands
		0000 0001	1	Calibration Timeout - Restart calibration
		0000 0010	2	ADC Error - Re-energize the instrument
		0000 0011	3	Instrument cannot be calibrating - Check load cell cable - Re-energize the instrument
		0010 0010	34	Instrument cannot be calibrating - Load cell signal is very low or too high
		0010 0011	35	Calibration Error - Calibration loading is not enough - Check test weight loading (Write test weight value to 1 st Dword of PLC Output to BX14 PN Input then restart the calibration) - Check load cell connections
		0010 0100	36	Calibration load value entry Error - Test weight is too small. Increase the test weight
		0010 0101	37	Scale unstable - Wait until scale become stable - Check grounding wiring
		0010 0110	38	The Calibration DIP switch is not 'On' position. - Check the calibration DIP switch.
D7 ... D0	Calibration Process Status	0000 0001	1	System ready for calibration
		0000 0011	3	Zero calibration in process
		0000 0100	4	Span calibration in process
		0000 1001	9	Error (Refer to Calibration Errors)

Table 11-2 - Calibration status

PLC Output to BX14 PN Input

Bitwise of a Dword:

Dword (R/W)	D31	D30	D29	D28	D27	D26	D25	D24	D23	D22	D21	D20	D19	D18	D17	D16
	D15	D14	D13	D12	D11	D10	D9	D8	D7	D6	D5	D4	D3	D2	D1	D0

1 st Dword	Next Dword defines the usage of this Dword.															
2 nd Dword	Not used	SFE	Reset	Filling Start	BY- PASS	Not used	Expanded Commands List									
	Not in use				Command List				Read Data Selection				New CMD			

PLC Output to BX14 PN Input 2nd Dword

Bit Number	2 nd Dword descriptions					
D31 ... D30	Not used					
D29	Start for emptying (SFE)	A transition from 0 to 1 activates the "Start for emptying" command.				
D28	Reset	A transition from 0 to 1 activates the "Reset" command.				
D27	Start for filling	A transition from 0 to 1 activates the "Start for filling" command.				
D26	By-Pass	A transition from 0 to 1 activates the by-pass function and transition from 1 to 0 deactivates the by-pass function.				
D25 ... D24	Not used					
D23 ... D16	Expanded Commands List (Refer to Table 11-3)					
D15 ... D11	Not in use					
D10 ... D6	Command List	Bin	Dec	Commands		
		00000	0	None command is activated		
		00001	1	Zero		
		00010	2	Tare		
		00011	3	Clear		
		00100	4	Print		
		00101	5	Adjust zero calibration		Calibration
		00110	6	Adjust span calibration ⁽¹⁾		
		00111	7	Total Load Cell Capacity ⁽¹⁾		eCal Coefficients
		01000	8	Average mV/V value ⁽¹⁾		
		01001	9	Dead Load value ⁽¹⁾		
		01010	10	Save the coefficients of eCal		
					<i>Refer to par. [313]</i>	

D10 ... D6	Command List (continuation of previous page)	01011	11	Not used
		10000	16	
		10001	17	Target value ^[1]
		10010	18	Not used
		10011	19	Coarse value ^[1]
		10100	20	Not used
		10101	21	Fine value ^[1]
		10110	22	Label number (CN) (Always integer) ^[1]
		10111	23	Not used
		11000	24	Quantity (Always integer) ^[1]
		11001	25	Total-1 ^[1] (Erasable total)
		11010	26	Not used
		11110	30	
11111	31	Use the Expanded Command list (Refer to Table 11-3)		
D5 ... D1	Read Selection Data	00000	0	Actual weight (Net if the indication is in Net)
		00001	1	Gross weight
		00010	2	Tare weight
		00011	3	Calibration Status (Refer to Table 11-2)
		00100	4	Not used
		01110	14	
		01111	15	Total-3 (Non-erasable total)
		10000	16	Not used
		10001	17	Target value
		10010	18	Not used
		10011	19	Coarse value
		10100	20	Not used
		10101	21	Fine value
		10110	22	Label number (CN) (Always integer)
		10111	23	Last filling value
		11000	24	Quantity (Always integer)
		11001	25	Total-1 (Erasable total)
		11010	26	Total-2 (The current day's total)
		11011	27	Total-4 (Yesterday's total)
		11100	28	Ton / hour indication (The actual flow rate)
11101	29	24 hours indication (Estimated daily total)		
11110	30	Process error messages (Refer to Table 11-1)		
11111	31	Use the Expanded Command list (Refer to Table 11-3)		
D0	New CMD	Toggle		Apply commands which are listed in this table

(1) Write this command after writing values to 1st Dword, then apply this command with New CMD

Expanded Command List (always 32 bit integer)

Here 1st Dword is the data receiving from PLC and the “D23 ... D16” bits describes below.

Bit No	Description						
D23...D16	Expanded Commands List	Bin	Dec	Commands			
		00000000	0	R	Voltage of Power Supply	Voltage of power supply is indicated with 0.1 VDC increment.	
		00000001 00011111	1 31	Not in use			
					Application parameters ⁽¹⁾		
		00100000	32	R/W	D_DISC	End of emptying delay	
		00100001	33	R/W	D_GATE	Gate control delay	
		00100010	34	R/W	ZERO_R	Zero range	
		00100011	35	R/W	T_TRGT	Total target	
		00100100	36	R/W	TON_HR	Flow rate	
		00100101	37	R/W	S_QTY	Sampling Quantity	
		00100110	38	R/W	GAT_CH	Gate position check	
		00100111 00111111	39 63	Not used			
		01000000	64	R/W	Filter ⁽¹⁾	Refer to par. [120] on page 53	
		01000001	65	Not used			
		01000010	66	R/W	Zeroing Range ⁽¹⁾	Refer to par. [203] on page 54	
		01000011	67	R/W	Auto Zero Tracking ⁽¹⁾	Refer to par. [204] on page 54	
		01000100	68	Not used			
		01000101	69	R/W	Motion Detector ⁽¹⁾	Refer to par. [206] on page 54	
		01000110 01000111	70 71	Not used			
		01001000	72	R/W	Capacity ⁽¹⁾	Refer to par. [212] on page 54	
		01001001	73	R/W	Decimal point ⁽¹⁾	0	XXXX00
						1	XXXXX0
						2	XXXXXX
						3	XXXXX.X
						4	XXXX.XX
		01001010	74	R/W	Increment ⁽¹⁾	1	X1
						2	X2
						3	X5
		01001011 01100000	75 96	Not Used			
		01100001	97	R/W	Feeding type ⁽¹⁾	Refer to par. [501] on page 58	
		01100010	98	R/W	Preact correction factor ⁽¹⁾	Refer to par. [502] on page 58	
		01100011	99	R/W	Not used		
01100100	100	R/W	Check delay ⁽¹⁾	Refer to par. [504] on page 59			
01100101	101	R/W	Zeroing period ⁽¹⁾	Refer to par. [505] on page 59			
01100110	102	R/W	Zeroing delay ⁽¹⁾	Refer to par. [506] on page 59			
01100111	103	R/W	Ind. at the end of filling ⁽¹⁾	Refer to par. [507] on page 59			
01101000	104	R/W	Feeding check time ⁽¹⁾	Refer to par. [508] on page 59			
01101001	105	R/W	Maximum filling weight ⁽¹⁾	Refer to par. [509] on page 59			

Table 11-3 - Expanded Command List

(1) Write this command after writing values to 1st Dword then apply this command with New CMD

Programming steps of frequent used

Reading a weight value:

1. Check the D11...D15 bits of 'BX14 PN Output to PLC Input 2nd Dword'.
2. If there is not any error, read a weight value (gross, net or tare),

Zero Calibration procedure:

1. Check the low byte of Calibration Status. it should be decimal '1' to start adjustment.
2. Write 'Adjust Zero Calibration' command and apply New CMD to start Zero calibration.
3. Check the low byte of Calibration Status. it is decimal '3' during zero calibration process.
4. The low byte of Calibration Status changes to decimal '1' at the end of the Zero calibration.
5. If the low byte of Calibration Status is '9', check the high byte of Calibration Status to understand the calibration error.

Span Calibration procedure:

1. Check the low byte of Calibration Status. it should be decimal '1' to start adjustment.
2. Write 'Adjust Span Calibration' command after writing test weight values to 1st Dword, then apply this command with New CMD to start Span calibration.
3. Check the low byte of Calibration Status. it is decimal '4' during span calibration process.
4. The low byte of Calibration Status changes to decimal '1' at the end of the Span calibration.
5. If the low byte of Calibration Status is '9', check the high byte of Calibration Status to understand the calibration error.

12. ETHERNET TCP/IP (ONLY BX14 EN)

Ethernet output of BX14 EN is programmable to BSI command set, Continuous data output, Fast continuous data output, Modbus TCP/IP High-Low, Modbus TCP/IP Low-High. The first three data structures can be found in the related sections indicated in the table below.

You can find below the difference of Low-High and High-Low data formats and some companies using these formats.

Data Format	Description	Company samples
BSI Command set	Refer to <i>Page 31</i>	
Continuous	Refer to <i>Page 31</i>	-
Fast Continuous	Refer to <i>Page 30</i>	-
Modbus TCP High-Low	Modbus TCP interfacing. Refer to <i>Page 90</i> .	Interfacing with PLC.
Modbus TCP Low-High	Modbus TCP interfacing. Refer to <i>Page 90</i> .	Interfacing with PLC.

Table 12-1 - Ethernet output interfacing

You can communicate with the controller after programming Ethernet TCP/IP and Modbus TCP related parameters [**03-**] on *Page 49*.

12.1 Ethernet Setup

There are 11 parameters for Ethernet network and Ethernet set up is done by EtherX PC software over Local Network Area as described in this section or you can enter from par. [**03-**] blocks. EtherX PC software is available in CD which is supplied together with the instrument.

Host Name

Device name of the instrument.

Default is ' '.

IP Address

Obtain IP address manually.

Default is '192.168.16.250'.

Local Port

Ethernet connection port of the instrument.

Default is '502'.

Gateway

Network point that acts as an entrance to another network.

Default is '192.168.16.253'.

Subnet Mask

Describes IP address can be used in network.

Default is '255.255.255.0'.

Primary DNS

Obtain primary DNS manually.

Default is '208.67.222.222'.

Secondary DNS

Obtain secondary DNS manually.

Default is '208.67.220.220'.

Remote Connection

Automatic connection to any device on the network.

Default is 'Disabled'.

Remote IP : IP address of the PC or Device to be connected automatically.

Remote Port : Ethernet connection point of PC or Device to be connected automatically.

Password

Factory default password is 123456 .

12.2 Modbus TCP Data Structure

If the instrument is programmed for Modbus TCP/IP, it can be used as a Modbus TCP/IP slave on Ethernet communication network. Functions code '0x03' (Read Holding Registers), '0x06' (Single Write Register), '0x10' (Preset Multiple Registers) and '0x17' (Read/Write Multiple Registers) are supported.

Modbus TCP/IP High-Low: In two word registers, the data is stored to the registers in big-endian format. Least significant word is stored to the highest register address; and most significant word is stored to the lowest register address.

Modbus TCP/IP Low-High: In two word registers, the data is stored to the registers in little-endian format. Least significant word is stored to the lowest register address; and most significant word is stored to the highest register address.

Parameter's set-up:

Set Ethernet Data Format : Modbus TCP/IP High-Low or Modbus TCP/IP Low-High

Ethernet Address : 01 to 255

Make the Ethernet parameter settings as defined on *Page 49*.

Please find Modbus information in the web site of <http://www.modbus.org>

Modbus TCP/IP Command Table;

Address	R/W	Word	Command	Definition			
40001	R	2	Actual weight (Net if the indication is in Net)				
40003	R	1	Status	Bit	Description		
				D0	0 – System Ready	1 – System Busy	
				D1	0 – Error (D13-D15)	1 – Data ok	
				D2	0 – Weight Stable	1 – Weight unstable	
				D3	0 – Gross Mode	1 – Net mode	
				D4	Not used		
				D5	0 - No error in process	1 – Process error (refer to 40113)	
				D6 – D11	Not used		
				D12	0 – Out of zero range	1 – Weight is in zero range	
				D13 D14 D15	Error Code	Dec	Description
						0	No Errors
	1	ADC out of range					
	2	ADC over range					
	3	ADC under range					
	4	System error					
	5	In programming mode					
	6	Low/High voltage det.					
40004	R	2	Tare weight				
40006	R	2	Gross weight				
40008	R	1	Status	Motion, Net mode, Data ok, (image of register 40003)			

40009	R/W	1	Control	Dec	Description		
				0	None		
				1	Zero		
				2	Tare		
				3	Clear		
				4	Print		
				8	Start for filling		
				9	Reset		
				14	Start for emptying		
				15	By-Pass function enable		
16	By-Pass function disable						
40010	R/W	1	Not used				
40011	R/W	2	Target value	Refer to page 38			
40013	R/W	2	Not used				
40015	R/W	2	Coarse value	Refer to page 38			
40017	R/W	2	Fine value	Refer to page 38			
40019	R/W	1	CN (Label number)	Refer to parameter [142] on page 53			
40020	R	2	Last filling value				
40022	R/W	1	Quantity				
40023	R/W	2	Total-1	Erasable total			
40025	R	1	Digital inputs status	Bit	Description		
				D0	Input-1	0 - Passive 1 - Active	
				D1	Input-2		
				D2	Input-3		
				D3	Input-4		
				D4	Not used		
				D5	Not used		
				D6	Pipe is clogged		
D7	By-Pass						
40026	R	2	Digital outputs status	D0	Output-1	0 - Passive 1 - Active	
				D1	Output-2		
				D2	Output-3		
				D3	Output-4		
				D4	Output-5		
40028	R/W	2	Not used				
40030	R/W	1	Calibration	Dec	Description		
				0	None		
				188	Adjust Zero Calibration		
				220	Adjust Span Calibration ⁽¹⁾		
				236	Total Load Cell Capacity ⁽¹⁾	eCal Coefficients	
				250	Average mV/V ⁽¹⁾		
				171	Dead Load ⁽¹⁾		
23205	Save the coefficients of eCal						

40031	R/W	2	Span Calibration Value / LC capacity / mV value / Dead load value			
40033	R	1	Calibration Status	D0 .. D7 Calibration Process Status	Dec	Description
					1	Ready for calibration
					3	Zero calibration in process ...
					4	Span calibration in process ...
				9	Error (Refer to D8 ... D15)	
				D8 .. D15 Calibration Errors	1	Calibration Timeout - Restart calibration
					2	ADC Error - Re-energize the instrument - If seen again, change the board.
					3	Instrument cannot be calibrating - Check load cell cable - Re-energize the instrument
					34	Instrument cannot be calibrating - Load cell signal is very low or too high
					35	Calibration Error - Calibration loading is not enough - Check test weight loading - Check load cell connections
					36	Calibration load value entry Error - Test weight is too small. Increase the weight
					37	Scale unstable - Wait until scale become stable - Check grounding wiring
				38	The Calibration DIP switch is not 'On' position. - Check the calibration DIP switch.	
40034	R/W	6	Not used			
Application Parameters						
40040	R/W	2	D_DISC	End of emptying delay		
40042	R/W	2	D_GATE	Gate control delay		
40044	R/W	2	ZERO_R	Zero range		
40046	R/W	2	T_TRGT	Total target		
40048	R/W	2	TON_HR	Flow rate		
40050	R/W	2	S_QTY	Sampling Quantity		
40052	R/W	2	GAT_CH	Gate position check		
40054	R/W	17	Not used			
40071	R	1	Actual weight	(image of register 40001)		
40072	R	1	Status	(image of register 40003)		
40073	R	1	Tare weight	(image of register 40004)		
40074	R	1	Gross weight	(image of register 40006)		

40100	R	1	Voltage of Power Supply	Voltage of power supply is indicated with 0.1 V increment. For example: 23.4 VDC is indicated as integer 234 value.	
40101	R	2	Ton/hour indication	The actual flow rate	
40103	R	2	24 hours indication	Estimated daily total	
40105	R/W	2	Total-1	Erasable total (Image of register 40023)	
40107	R	2	Total-2	The current day's total	
40109	R	2	Total-4	Yesterday's total	
40111	R	2	Total-3	Non-erasable total	
40113	R	1	Proses warning Messages	Dec	Description
				0	No process error
				1	END
				2	BY-PASS
				3	NO FEED
			Proses Error Messages	4	RESET
				128	E GATE
				129-135	Not used
				136	E FEED
40114	R	1	Process state	0	No process (Adc out, Over, Under etc.)
				1	Ready
				2	In filling process
				3	End of filling (FULL)
				4	In discharging process
				5	Delay of flow rate control ([d_tonh] message)
42000	R/W	1	Filter	Refer to parameter [120] on page 53	
42001	R/W	1	Not used		
42002	R/W	1	Zeroing Range	Refer to parameter [203] on page 54	
42003	R/W	1	Auto Zero Tracking	Refer to parameter [204] on page 54	
42004	R/W	1	Not used		
42005	R/W	1	Motion Detector	Refer to parameter [206] on page 54	
42006	R/W	2	Not used		
42008	R/W	2	Capacity	Refer to parameter [212] on page 54	
42010	R/W	1	Decimal point	Dec	Description
				0	XXXX00
				1	XXXXX0
				2	XXXXXX
				3	XXXXX.X
				4	XXXX.XX
42011	R/W	1	Increment	Dec	Description
				1	X 1
				2	X 2
				3	X 5

42101	R/W	1	Feeding type	Refer to parameter [501] on page 58
42102	R/W	1	Preact correction factor	Refer to parameter [502] on page 58
42103	R/W	1	Not used	
42104	R/W	1	Check delay	Refer to parameter [504] on page 59
42105	R/W	1	Zeroing period	Refer to parameter [505] on page 59
42106	R/W	1	Zeroing delay	Refer to parameter [506] on page 59
42107	R/W	1	Indication at the end of filling	Refer to parameter [507] on page 59
42108	R/W	1	Feeding check time	Refer to parameter [508] on page 59
42109	R/W	2	Maximum filling weight	Refer to parameter [509] on page 59

(1) Write this command after writing values to 40031-32 addresses.

Programming steps of frequent used

Reading a weight value:

1. Read 40003 (or 40008, 40073),
2. Check D0=0, D1=1 and D5=0,
3. If yes, read a weight value (gross, net or tare),
4. If D0=1, check D0 until system ready,
5. If D1=0, check the error code or if D5=1, check the process error messages from 40105.

Zero Calibration procedure:

1. Check the low byte of 40033. it should be decimal '1' to start adjustment.
2. Load the decimal '188' to 40030 to start Zero calibration.
3. Check the low byte of 40033. it is decimal '3' during zero calibration process.
4. The low byte of 40033 changes to decimal '1' at the end of the Zero calibration.
5. If the low byte of 40033 is '9', check the high byte of 40033 to understand the calibration error.

Span Calibration procedure:

1. Check the low byte of 40033. it should be decimal '1' to start adjustment.
2. First load the span value to 40031-32 and then load the decimal '220' to 40030 to start Span calibration.
3. Check the low byte of 40033. it is decimal '4' during span calibration process.
4. The low byte of 40033 changes to decimal '1' at the end of the Span calibration.
5. If the low byte of 40033 is '9', check the high byte of 40033 to understand the calibration error.

EXPLANATION:

Attention: For hardware connection details, please refer to the related hardware descriptions in this manual.

Exception codes:

- 1: Function code is not supported.
- 2: Out of beginning and ending address range.
- 3: Invalid value entrance or wrong byte number.
- 4: Operation error.

Command Examples:

Performing Read and Write operations according (Modbus TCP/IP High-Low) to hex system with the instrument set to address "0x01". MBAP (Modbus Application Protocol) Header is not included to the below Modbus TCP/IP application data units.

Below you will find some command samples;

Description	Hex
Request weight data	01,03,00,00,00,02
Answer of request weight (weight value is 100000)	01,03,04,00,01,86,A0
Request status data	01,03,00,02,00,01
"Start for filling" Command	01,10,00,08,00,01,02,00,08
"Start for emptying" Command	01,10,00,08,00,01,02,00,0E
"Reset" Command	01,10,00,08,00,01,02,00,09
Zero Command	01,10,00,08,00,01,02,00,01
Read digital inputs	01,03,00,C7,00,01
Answer of digital inputs (Input-2 is active)	01,03,02,00,02
Read digital outputs	01,03,00,C8,00,01
Answer of digital outputs (Output-3 is Active)	01,03,02,00,04
Request Calibration Status	01,03,00,20,00,01
Answer of request Calibration Status (Instrument is ready for calibration)	01,03,02,00,01
Zero Calibration	01,10,00,1D,00,01,02,00,BC
Span Calibration Command with Span value 50000	01,10,00,1D,00,03,06,00,DC,00,00,C3,50
Total LC capacity Command with Total LC capacity value 100000	01,10,00,1D,00,03,06,00,EC,00,01,86,A0
Average mV/V Command with Average mV/V value 1.9999	01,10,00,1D,00,03,06,00,FA,00,00,4E,1F
Dead load Command with Dead load value 12345	01,10,00,1D,00,03,06,00,AB,00,00,30,39
Save the coefficients of eCal Command	01,10,00,1D,00,01,02,5A,A5
Read Voltage of Power Supply value	01,03,00,63,00,01
Answer of Voltage of Power Supply (Voltage of Power Supply is 23,5 V)	01,03,02,00,EB

13. CANOPEN (ONLY BX14 CO)

After setting related parameters to can communicate with the controller via CANopen network. EDS file is available in CD which is supplied together with the instrument.

Automatically detected and supported baud rates are 10 kbps, 50 kbps, 100 kbps, 125 kbps, 250 kbps, 500 kbps, 800 kbps, 1 Mbps, Autobaud (default).

There are 2 LED's near the CANopen connector which are;

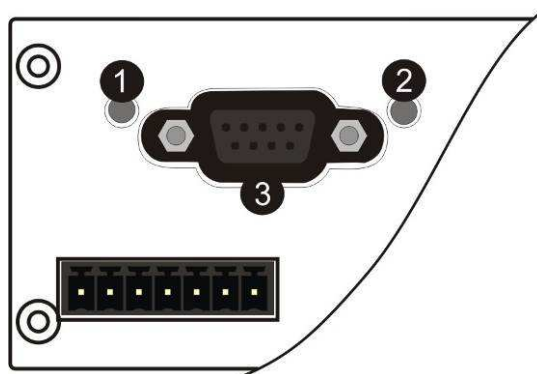

1	Run LED
2	Error LED
3	CANopen interface

Run LED

State	Indication	Comment
Off	Not online / No power	Check power and cable
Green	On-line, data exchange	-
Green, blinking	On-line, initializing	-
Green, single flash	Stopped	Check hardware damages
Green, flickering	Auto baudrate detection in progress	-
Red	CANopen configuration error	Check EDS file

Error LED

State	Indication	Comment
Off	-	No power or CANopen module is in initialization state
Red, single flash	Warning limit reached	A bus error counter reached or exceeded its warning level
Red, flickering	LSS	LSS services in progress
Red, double flash	Error count event	A guard- (NMT-Slave or NMT-master) or heartbeat event (Heartbeat consumer) has occurred.
Red	Bus off (Fatal Event)	Bus off.

13.1 Data Format

Data format of weight value can be programmable for Floating point (IEEE 754) or Integer. Refer to parameter [070].

13.2 EDS Configuration

CANopen data structures of BX14 CO includes 1 x TxPDO (64 bit) and 1 x RxPDO (64 bit). EDS configuration for PLC programmers is shown in Figure 13-1.

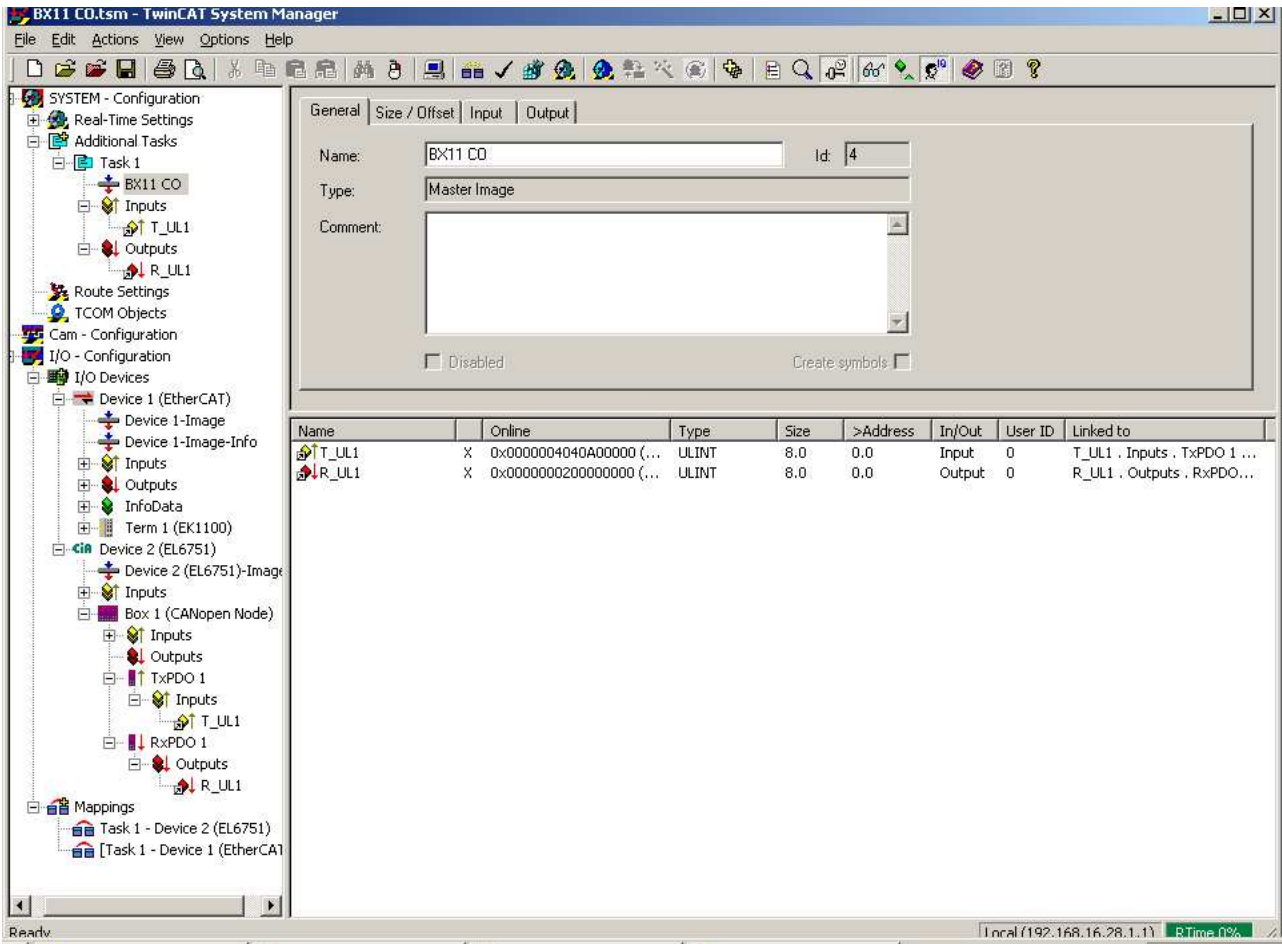

Figure 13-1 - EDS Configuration

ESD Configuration	Description
TxPDO 1 (4 words)	Unsigned Long (BX14 CO Output to PLC Input)
RxPDO 1 (4 words)	Unsigned Long (PLC Output to BX14 CO Input)

13.3 CANopen Data Structure

BX14 CO Output to PLC Input

Bitwise of a Ulong:

Unsigned Long (Only read)	D63	D62	D61	D60	D59	D58	D57	D56	D55	D54	D53	D52	D51	D50	D49	D48
	D47	D46	D45	D44	D43	D42	D41	D40	D39	D38	D37	D36	D35	D34	D33	D32
	D31	D30	D29	D28	D27	D26	D25	D24	D23	D22	D21	D20	D19	D18	D17	D16
	D15	D14	D13	D12	D11	D10	D9	D8	D7	D6	D5	D4	D3	D2	D1	D0

TxPDO 1 (T_UL1)				Out 5	Out 4	Out 3	Out 2	Out 1	By-Pass	Pipe is clog.			In 4	In 3	In 2	In 1
	Error codes of BX14 CO					Process Error		Centre of zero	Gross Net	MD	Read command response					Cmd Flg
	By default, Actual weight value is represented. To represent other weight or calibration status, refer to D33...D37.															

BX14 CO Output to PLC Input TxPDO 1 (T_UL1)

Bit Number	TxPDO 1 (T_UL1) Description			
D63 ... D56	Outputs	Output bit status (Active = 1)		
D55 ... D48	Inputs	Input bit status (Active = 1)		
D47 ... D44	Error Codes of BX14 CO	Bin	Dec	Descriptions
		0000	0	No error found
		0001	1	ADC out
		0010	2	ADC over
		0011	3	ADC under
		0100	4	System Error
		0101	5	In programming mode
		0110	6	Low/High Voltage Error
D43	Not in use			
D42	Process Error	0	No error	
		1	Process error (Check the 'Process error messages')	
D41	Not in use			
D40	Centre of zero	0	Weight is out of zero range	
		1	Weight is in zero range	
D39	Indication	0	Gross	
		1	Net	
D38	MD – Motion Detection	0	Stable	
		1	Dynamic	

D37 ... D33	Read Command Response	Bin	Dec	Descriptions
		00000	0	Actual weight (Net if the indication is in Net)
		00001	1	Gross weight
		00010	2	Tare weight
		00011	3	Calibration Status (Refer to Table 13-2)
		00100	4	Not used
		01110	14	
		01111	15	Total-3 (Non-erasable total)
		10000	16	Not used
		10001	17	Target value
		10010	18	Not used
		10011	19	Coarse value
		10100	20	Not used
		10101	21	Fine value
		10110	22	Label number (CN) (Always integer)
		10111	23	Last filling value
		11000	24	Quantity (Always integer)
		11001	25	Total-1 (Erasable total)
		11010	26	Total-2 (The current day's total)
11011	27	Total-4 (Yesterday's total)		
11100	28	Ton / hour indication (The actual flow rate)		
11101	29	24 hours indication (Estimated daily total)		
11110	30	Process error messages (Refer to Table 13-1)		
11111	31	Use the Expanded Command list (Refer to Table 13-3)		
D32	CMD Flag	Toggles	The command is applied successfully	
D31...D0	By default, Actual weight value is represented. To represent other weight or calibration status, refer to D33~D37.			

Process error messages (always 32 bit integer)

Low Dword of TxPDO 1 (T_UL1) descriptions when read command is 'Process error messages'. Refer to RxPDO 1 (R_UL1) of 'PLC Output to BX14 CO Input'.

Bit Number	Low Dword of TxPDO 1 (T_UL1) Description			
D31 ... D16	Not in use			
D15 ... D8	Process State	Bin	Dec	Process state
		00000000	0	No process (Adc out, Over, Under etc.)
		00000001	1	Ready
		00000010	2	In filling process
		00000011	3	End of filling (FULL)
		00000100	4	In discharging process
		00000101	5	Delay of flow rate control ([d_tonh] message)
D7 ... D0	Process warning Messages	Bin	Dec	Messages
		00000000	0	No process error
		00000001	1	END
		00000010	2	BY-PASS
		00000011	3	NO FEED
		00000100	4	RESET

	Process error Messages	10000000	128	E GATE
		10000001	129	Not used
		10000111	135	
		10001000	136	E FEED

Table 13-1– Process error messages

Calibration Status (always 32 bit integer)

Low Dword of TxPDO 1 (T_UL1) descriptions when read command is 'Calibration Status'. Refer to RxPDO 1 (R_UL1) of 'PLC Output to BX14 CO Input'.

Bit Number	Low Dword of TxPDO 1 (T_UL1) Description			
D31 ... D16	Not in use			
D15 ... D8	Calibration Errors	Bin	Dec	Commands
		0000 0001	1	Calibration Timeout - Restart calibration
		0000 0010	2	ADC Error - Re-energize the instrument
		0000 0011	3	Instrument cannot be calibrating - Check load cell cable - Re-energize the instrument
		0010 0010	34	Instrument cannot be calibrating - Load cell signal is very low or too high
		0010 0011	35	Calibration Error - Calibration loading is not enough - Check test weight loading (Write test weight value to RxPDO 1 (R_DW1) of PLC Output to BX14 CO Input then restart the calibration) - Check load cell connections
		0010 0100	36	Calibration load value entry Error - Test weight is too small. Increase the test weight
		0010 0101	37	Scale unstable - Wait until scale become stable - Check grounding wiring
		0010 0110	38	The Calibration DIP switch is not 'On' position. - Check the calibration DIP switch.
D7 ... D0	Calibration Process Status	0000 0001	1	System ready for calibration
		0000 0011	3	Zero calibration in process
		0000 0100	4	Span calibration in process
		0000 1001	9	Error (Refer to Calibration Errors)

Table 13-2 - Calibration status

PLC Output to BX14 CO Input

Bitwise of a Ulong:

Unsigned Long (R/W)	D63	D62	D61	D60	D59	D58	D57	D56	D55	D54	D53	D52	D51	D50	D49	D48
	D47	D46	D45	D44	D43	D42	D41	D40	D39	D38	D37	D36	D35	D34	D33	D32
	D31	D30	D29	D28	D27	D26	D25	D24	D23	D22	D21	D20	D19	D18	D17	D16
	D15	D14	D13	D12	D11	D10	D9	D8	D7	D6	D5	D4	D3	D2	D1	D0

RxPDO 1 (R_UL1)	Not used	SFE	Reset	Filling Start	BY-PASS	Not used	Expanded Commands List			
	Not used			Command List			Read Data Selection			New CMD
	D33~D37 bits defines the usage of this Dword.									

PLC Output to BX14 CO Input RxPDO 1 (R_UL1)

Bit Number	RxPDO 1 (R_UL1) descriptions				
D63 ... D62	Not used				
D61	Start for emptying (SFE)	A transition form 0 to1 activates the "Start for emptying" command.			
D60	Reset	A transition form 0 to1 activates the "Reset" command.			
D59	Start for filling	A transition form 0 to1 activates the "Start for filling" command.			
D58	By-Pass	A transition from 0 to1 activates the by-pass function and transition from 1 to 0 deactivates the by-pass function.			
D57 ... D56	Not used				
D55 ... D48	Expanded Commands List (Refer to Table 13-3)				
D47 ... D43	Not used				
D42 ... D38	Command List	Bin	Dec	Commands	
		00000	0	None command is activated	
		00001	1	Zero	
		00010	2	Tare	
		00011	3	Clear	
		00100	4	Print	
		00101	5	Adjust zero calibration	Calibration
		00110	6	Adjust span calibration ⁽¹⁾	
		00111	7	Total Load Cell Capacity ⁽¹⁾	eCal Coefficients
		01000	8	Average mV/V value ⁽¹⁾	
		01001	9	Dead Load value ⁽¹⁾	
01010	10	Save the coefficients of eCal	Refer to par. [313]		

D42 ... D38	Command List (continuation of previous page)	01011	11	Not used
		10000	16	
		10001	17	Target value ^[1]
		10010	18	Not used
		10011	19	Coarse value ^[1]
		10100	20	Not used
		10101	21	Fine value ^[1]
		10110	22	Label number (CN) (Always integer) ^[1]
		10111	23	Not used
		11000	24	Quantity (Always integer) ^[1]
		11001	25	Total-1 ^[1] (Erasable total)
		11010	26	Not used
11110	30			
11111	31	Use the Expanded Command list (Refer to Table 13-3)		
D37 ... D33	Read Selection Data	00000	0	Actual weight (Net if the indication is in Net)
		00001	1	Gross weight
		00010	2	Tare weight
		00011	3	Calibration Status (Refer to Table 13-2)
		00100	4	Not used
		01110	14	
		01111	15	Total-3 (Non-erasable total)
		10000	16	Not used
		10001	17	Target value
		10010	18	Not used
		10011	19	Coarse value
		10100	20	Not used
		10101	21	Fine value
		10110	22	Label number (CN) (Always integer)
		10111	23	Last filling value
		11000	24	Quantity (Always integer)
		11001	25	Total-1 (Erasable total)
		11010	26	Total-2 (The current day's total)
		11011	27	Total-4 (Yesterday's total)
		11100	28	Ton / hour indication (The actual flow rate)
11101	29	24 hours indication (Estimated daily total)		
11110	30	Process error messages (Refer to Table 13-1)		
11111	31	Use the Expanded Command list (Refer to Table 13-3)		
D32	New CMD	Toggle	Apply commands which are listed in this table	
D31~D0	D33~D37 bits defines the usage of this Dword.			

(1) Write this command with writing values to D0...D31 bits then apply New CMD.

Expanded Command List (always 32 bit integer)

Here TxPDO 1 (T_UL1) is the data receiving from PLC and the “D48 ... D55” bits describes below.

Bit No	Description						
D48...D55	Expanded Commands List	Binary	Dec	R/W	Commands		
		00000000	0	R	Voltage of Power Supply	Voltage of power supply is indicated with 0.1 VDC increment.	
		00000001 00011111	1 31	Not in use			
					Application Parameters ⁽¹⁾		
		00100000	32	R/W	D_DISC	End of emptying delay	
		00100001	33	R/W	D_GATE	Gate control delay	
		00100010	34	R/W	ZERO_R	Zero range	
		00100011	35	R/W	T_TRGT	Total target	
		00100100	36	R/W	TON_HR	Flow rate	
		00100101	37	R/W	S_QTY	Sampling Quantity	
		00100110	38	R/W	GAT_CH	Gate position check	
		00100111 00111111	39 63	Not used			
		01000000	64	RW	Filter ⁽¹⁾	Refer to par. [120] on page 53	
		01000001	65	Not used			
		01000010	66	RW	Zeroing Range ⁽¹⁾	Refer to par. [203] on page 54	
		01000011	67	RW	Auto Zero Tracking ⁽¹⁾	Refer to par. [204] on page 54	
		01000100	68	Not used			
		01000101	69	RW	Motion Detector ⁽¹⁾	Refer to par. [206] on page 54	
		01000110 01000111	70 71	Not used			
		01001000	72	RW	Capacity ⁽¹⁾	Refer to par. [212] on page 54	
		01001001	73	RW	Decimal point ⁽¹⁾	0	XXXX00
						1	XXXXX0
						2	XXXXXX
						3	XXXXX.X
						4	XXXX.XX
						5	XXX.XXX
		01001010	74	RW	Increment ⁽¹⁾	1	X1
						2	X2
						3	X5
		01001011 01100000	75 96	Not Used			
		01100001	97	R/W	Feeding type ⁽¹⁾	Refer to par. [501] on page 58	
		01100010	98	R/W	Preact correction factor ⁽¹⁾	Refer to par. [502] on page 58	
01100011	99	R/W	Not used				
01100100	100	R/W	Check delay ⁽¹⁾	Refer to par. [504] on page 59			
01100101	101	R/W	Zeroing period ⁽¹⁾	Refer to par. [505] on page 59			
01100110	102	R/W	Zeroing delay ⁽¹⁾	Refer to par. [506] on page 59			
01100111	103	R/W	Ind. at the end of filling ⁽¹⁾	Refer to par. [507] on page 59			
01101000	104	R/W	Feeding check time ⁽¹⁾	Refer to par. [508] on page 59			
01101001	105	R/W	Maximum filling weight ⁽¹⁾	Refer to par. [509] on page 59			

Table 13-3 - Expanded Command List

(1) Write this command with writing values to D0~D31 bits then apply New CMD.

Programming steps of frequent used

Reading a weight value:

1. Check the D43...D47 bits of 'TxPDO 1 (T_UL1)'.
2. If there is not any error, read a weight value (gross, net or tare),

Zero Calibration procedure:

1. Check the low byte of Calibration Status. it should be decimal '1' to start adjustment.
2. Write 'Adjust Zero Calibration' command and apply New CMD to start Zero calibration.
3. Check the low byte of Calibration Status. it is decimal '3' during zero calibration process.
4. The low byte of Calibration Status changes to decimal '1' at the end of the Zero calibration.
5. If the low byte of Calibration Status is '9', check the high byte of Calibration Status to understand the calibration error.

Span Calibration procedure:

1. Check the low byte of Calibration Status. it should be decimal '1' to start adjustment.
2. Write 'Adjust Span Calibration' command with writing test weight values to Low Dword of RxPDO1 (R_UL1), then apply New CMD to start Span calibration.
3. Check the low byte of Calibration Status. it is decimal '4' during span calibration process.
4. The low byte of Calibration Status changes to decimal '1' at the end of the Span calibration.
5. If the low byte of Calibration Status is '9', check the high byte of Calibration Status to understand the calibration error.

14. ETHERNET/IP (ONLY BX14 EI)

EtherNet/IP interface of the weighing instrument can be done via hub switch or serial bus over two EtherNet/IP port.

1. Serial bus connection of instruments. You may connect instruments serial to your EtherNet/IP bus via two ports.
2. Star connection. If you connect the instrument to your PLC via hub switch, you can use P1 or P2 port on the instrument. You may change the port, if there is any malfunction on port in usage.

The EtherNet/IP interface supports 10/100Mbit, full or half duplex operation. EDS file for two port EtherNet/IP is available in CD which is supplied together with the instrument.

There are 4 announcement LEDs on the instrument to indicate the interface status as seen below. The meanings of these LED's are;

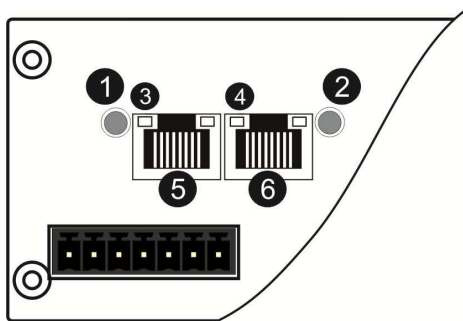

1	NS Network Status LED
2	MS Module Status LED
3	Link/Activity LED (port 1)
4	Link/Activity LED (port 2)
5	P1 interface (port 1)
6	P2 interface (port 2)

NS Network Status LED

LED State	Description
Off	Not IP address
Green	Online, one or more connections established (CIP Class 1 or 3)
Green, flashing	Online, no connections established
Red	Duplicate IP address, FATAL error
Red, flashing	One or more connections timed out (CIP Class 1 or 3)

MS Module Status LED

LED State	Description
Off	No power
Green	Controlled by a scanner in run state
Green, flashing	Not configured, or scanner in idle state
Red	Major fault (EXCEPTION state, FATAL error etc.)
Red, flashing	Recoverable fault(s)

In the case of red LED warning, check cabling, configuration and IP address before reenergizing the instrument after 30 seconds power off.

LINK/Activity LED

LED State	Description
Off	No link, no activity
Green	Link (100 Mbit/s) established
Green, flickering	Activity (100 Mbit/s)
Yellow	Link (10 Mbit/s) established
Yellow, flickering	Activity (10 Mbit/s)

14.1 Data Format

Data format of weight value can be programmable for Floating point (IEEE 754) or Integer. Refer to parameter [060].

14.2 EtherNet/IP Parameters

There are 7 parameters for EtherNet/IP network and EtherNet/IP set up is done by EtherX PC software over Local Network Area as described in this section. EtherX PC software is available in CD which is supplied together with the instrument.

DHCP

Dynamic Host Configuration Protocol automates network parameters if it is enabled.

Default is 'Enable'.

IP Address

If DHCP is disabled, obtain IP address manually.

Subnet Mask

If DHCP is disabled, obtain subnet mask manually.

Default Gateway

If DHCP is disabled, obtain default gateway manually.

Primary DNS

If DHCP is disabled, obtain primary DNS manually.

Secondary DNS

If DHCP is disabled, obtain secondary DNS manually.

Host Name

Enter a unique host name to the instrument.

Default is ' '.

14.3 EDS Configuration

EtherNet/IP data structures of BX14 includes 2 x Input 2 words and 2 x Output 2 words. EDS configuration for PLC programmers is shown in Figure 14.1 and Figure 14.2.

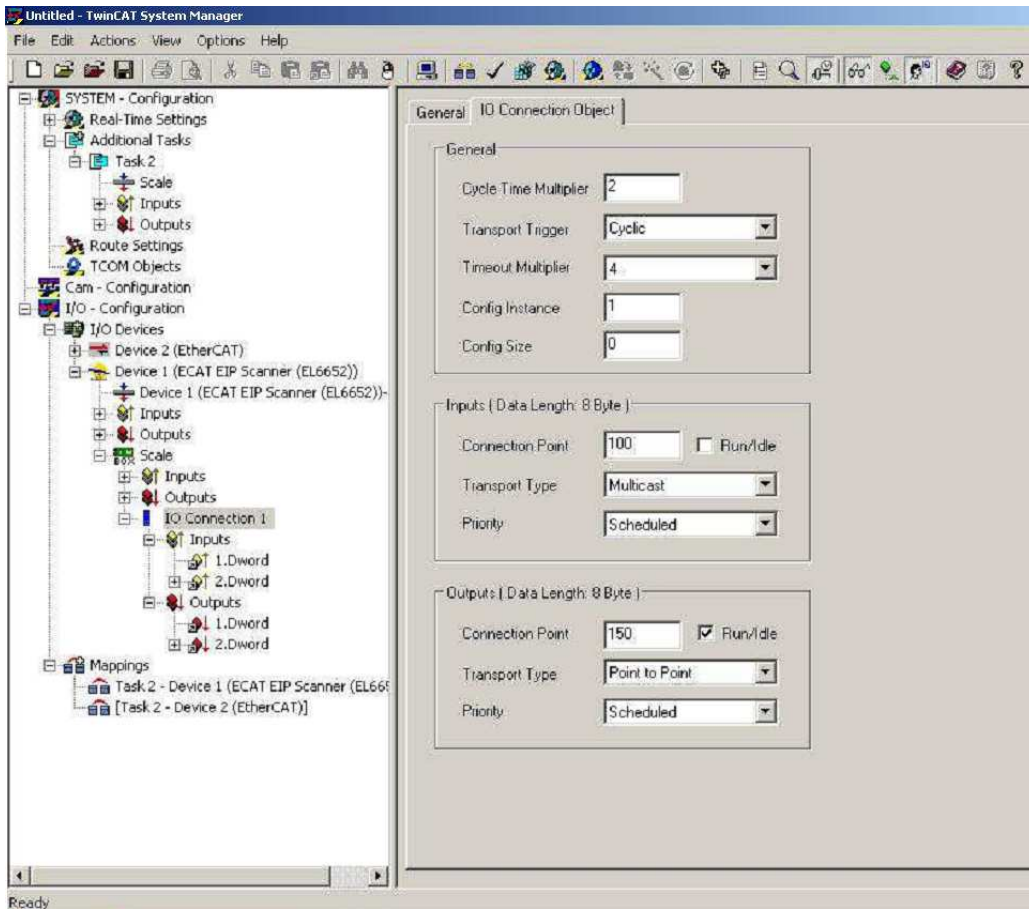

Figure 14.1 – Configuration of module properties without EDS file

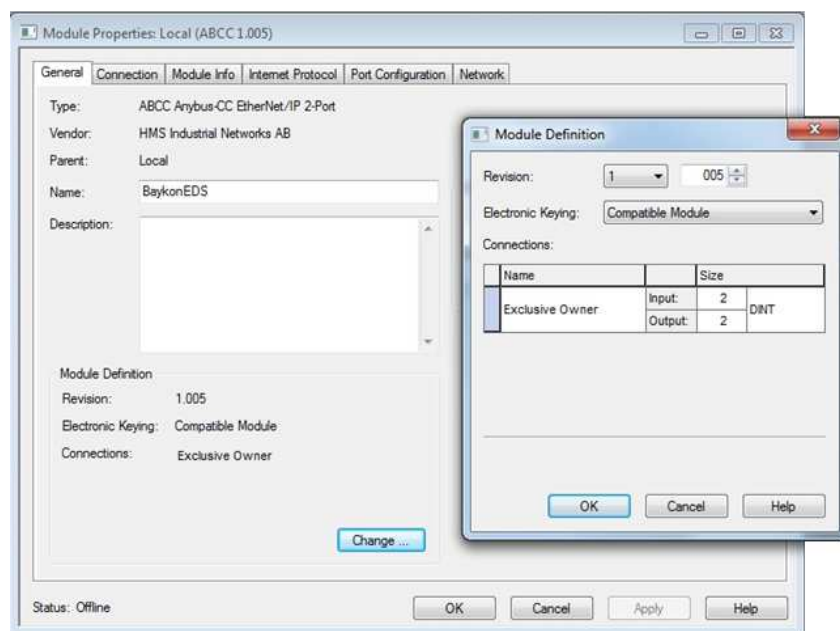

Figure 14.2 – Configuration of module properties with EDS file

Data Length	Description
Input 2 words	1 st Dword (<i>BX14 Output to PLC Input</i>)
Input 2 words	2 nd Dword (<i>BX14 Output to PLC Input</i>)
Output 2 words	1 st Dword (<i>PLC Output to BX14 Input</i>)
Output 2 words	2 nd Dword (<i>PLC Output to BX14 Input</i>)

14.4 EtherNet/IP Data Structure

BX14 Output to PLC Input

Bitwise of a Dword:

Dword (Only read)	D31	D30	D29	D28	D27	D26	D25	D24	D23	D22	D21	D20	D19	D18	D17	D16
	D15	D14	D13	D12	D11	D10	D9	D8	D7	D6	D5	D4	D3	D2	D1	D0

1 st Dword	By default, Actual weight value is represented. To represent other weight or calibration status, refer to next Dword.															
2 nd Dword				Out 5	Out 4	Out 3	Out 2	Out 1	By- Pass	Pipe is clog.			In 4	In 3	In 2	In 1
	Error codes of BX14					Process Error		Centre of zero	Gross Net	MD	Read command response					Cmd Flg

BX14 Output to PLC Input 2nd Dword

Bit Number	2 nd Dword Description			
D31 ... D24	Outputs	Output bit status (Active = 1)		
D23 ... D16	Inputs	Input bit status (Active = 1)		
D15 ... D12	Error Codes of BX14	Bin	Dec	Descriptions
		0000	0	No error found
		0001	1	ADC out
		0010	2	ADC over
		0011	3	ADC under
		0100	4	System Error
		0101	5	In programming mode
		0110	6	Low/High Voltage Error
D11	Not in use			
D10	Process Error	0	No error	
		1	Process error (Check the 'Process error messages')	
D9	Not in use			
D8	Centre of zero	0	Weight is out of zero range	
		1	Weight is in zero range	
D7	Indication	0	Gross	
		1	Net	
D6	MD – Motion Detection	0	Stable	
		1	Dynamic	
D5 ... D1	Read Command Response	00000	0	Actual weight (Net if the indication is in Net)
		00001	1	Gross weight
		00010	2	Tare weight
		00011	3	Calibration Status (Refer to Table 14-2)
		00100	4	Not used
		01110	14	

D5 ... D1	Read Command Response (continuation of previous page)	01111	15	Total-3	(Non-erasable total)
		10000	16	Not used	
		10001	17	Target value	
		10010	18	Not used	
		10011	19	Coarse value	
		10100	20	Not used	
		10101	21	Fine value	
		10110	22	Label number (CN)	(Always integer)
		10111	23	Last filling value	
		11000	24	Quantity	(Always integer)
		11001	25	Total-1	(Erasable total)
		11010	26	Total-2	(The current day's total)
		11011	27	Total-4	(Yesterday's total)
		11100	28	Ton / hour indication	(The actual flow rate)
		11101	29	24 hours indication	(Estimated daily total)
11110	30	Process error messages	(Refer to Table 14-1)		
	11111	31	Use the Expanded Command list (Refer to Table 14-3)		
D0	CMD Flag	Toggles		The command is applied successfully	

Process error messages (always 32 bit integer)

1st Dword descriptions when read command is 'Process error messages'. Refer to 2nd Dword of PLC Output to BX14 Input.

Bit Number	1 st Dword Description			
D31 ... D16	Not in use			
D15 ... D8	Process State	Bin	Dec	Process state
		00000000	0	No process (Adc out, Over, Under etc.)
		00000001	1	Ready
		00000010	2	In filling process
		00000011	3	End of filling (FULL)
		00000100	4	In discharging process
		00000101	5	Delay of flow rate control ([d_tonh] message)
D7 ... D0	Process warning Messages	Bin	Dec	Messages
		00000000	0	No process error
		00000001	1	END
		00000010	2	BY-PASS
		00000011	3	NO FEED
	00000100	4	RESET	
	Process error Messages	10000000	128	E GATE
		10000001	129	Not used
		10000111	135	
10001000		136	E FEED	

Table 14-1– Process error messages

Calibration Status (always 32 bit integer)

1st Dword descriptions when read command is 'Calibration Status'. Refer to 2nd Dword of PLC Output to BX14 Input.

Bit Number	1 st Dword Description			
D31 ... D16	Not in use			
D15 ... D8	Calibration Errors	Bin	Dec	Commands
		0000 0001	1	Calibration Timeout - Restart calibration
		0000 0010	2	ADC Error - Re-energize the instrument
		0000 0011	3	Instrument cannot be calibrating - Check load cell cable - Re-energize the instrument
		0010 0010	34	Instrument cannot be calibrating - Load cell signal is very low or too high
		0010 0011	35	Calibration Error - Calibration loading is not enough - Check test weight loading (Write test weight value to 1 st Dword of PLC Output to BX14 Input then restart the calibration) - Check load cell connections
		0010 0100	36	Calibration load value entry Error - Test weight is too small. Increase the test weight
		0010 0101	37	Scale unstable - Wait until scale become stable - Check grounding wiring
		0010 0110	38	The Calibration DIP switch is not 'On' position. - Check the calibration DIP switch.
D7 ... D0	Calibration Process Status	0000 0001	1	System ready for calibration
		0000 0011	3	Zero calibration in process
		0000 0100	4	Span calibration in process
		0000 1001	9	Error (Refer to Calibration Errors)

Table 14-2 - Calibration status

PLC Output to BX14 Input

Bitwise of a Dword:

Dword (R/W)	D31	D30	D29	D28	D27	D26	D25	D24	D23	D22	D21	D20	D19	D18	D17	D16
	D15	D14	D13	D12	D11	D10	D9	D8	D7	D6	D5	D4	D3	D2	D1	D0

1 st Dword	Next Dword defines the usage of this Dword.															
2 nd Dword	Not used	SFE	Reset	Filling Start	BY- PASS	Not used	Expanded Commands List									
	Not in use				Command List				Read Data Selection				New CMD			

PLC Output to BX14 Input 2nd Dword

Bit Number	2 nd Dword descriptions				
D31 ... D30	Not used				
D29	Start for emptying (SFE)	A transition from 0 to 1 activates the "Start for emptying" command.			
D28	Reset	A transition from 0 to 1 activates the "Reset" command.			
D27	Start for filling	A transition from 0 to 1 activates the "Start for filling" command.			
D26	By-Pass	A transition from 0 to 1 activates the by-pass function and transition from 1 to 0 deactivates the by-pass function.			
D25 ... D24	Not used				
D23 ... D16	Expanded Commands List (Refer to Table 14-3)				
D15 ... D11	Not in use				
D10 ... D6	Command List	Bin	Dec	Commands	
		00000	0	None command is activated	
		00001	1	Zero	
		00010	2	Tare	
		00011	3	Clear	
		00100	4	Print	
		00101	5	Adjust zero calibration	Calibration
		00110	6	Adjust span calibration ⁽¹⁾	
		00111	7	Total Load Cell Capacity ⁽¹⁾	eCal Coefficients
		01000	8	Average mV/V value ⁽¹⁾	
		01001	9	Dead Load value ⁽¹⁾	
		01010	10	Save the coefficients of eCal	
		01011	11	Not used	
10000	16				

D10 ... D6	Command List (continuation of previous page)	10001	17	Target value ^[1]
		10010	18	Not used
		10011	19	Coarse value ^[1]
		10100	20	Not used
		10101	21	Fine value ^[1]
		10110	22	Label number (CN) (Always integer) ^[1]
		10111	23	Not used
		11000	24	Quantity (Always integer) ^[1]
		11001	25	Total-1 ^[1] (Erasable total)
		11010 11110	26 30	Not used
		11111	31	Use the Expanded Command list (Refer to Table 14-3)
D5 ... D1	Read Selection Data	00000	0	Actual weight (Net if the indication is in Net)
		00001	1	Gross weight
		00010	2	Tare weight
		00011	3	Calibration Status (Refer to Table 14-2)
		00100 01110	4 14	Not used
		01111	15	Total-3 (Non-erasable total)
		10000	16	Not used
		10001	17	Target value
		10010	18	Not used
		10011	19	Coarse value
		10100	20	Not used
		10101	21	Fine value
		10110	22	Label number (CN) (Always integer)
		10111	23	Last filling value
		11000	24	Quantity (Always integer)
		11001	25	Total-1 (Erasable total)
		11010	26	Total-2 (The current day's total)
		11011	27	Total-4 (Yesterday's total)
		11100	28	Ton / hour indication (The actual flow rate)
		11101	29	24 hours indication (Estimated daily total)
11110	30	Process error messages (Refer to Table 14-1)		
11111	31	Use the Expanded Command list (Refer to Table 14-3)		
D0	New CMD	Toggle		Apply commands which are listed in this table

(1) Write this command after writing values to 1st Dword, then apply this command with New CMD

Expanded Command List (always 32 bit integer)

Here 1st Dword is the data receiving from PLC and the “D23 ... D16” bits describes below.

Bit No	Description						
D23...D16	Expanded Commands List	Bin	Dec	Commands			
		00000000	0	R	Voltage of Power Supply	Voltage of power supply is indicated with 0.1 VDC increment.	
		00000001 00011111	1 31	Not in use			
					Application parameters ⁽¹⁾		
		00100000	32	R/W	D_DISC	End of emptying delay	
		00100001	33	R/W	D_GATE	Gate control delay	
		00100010	34	R/W	ZERO_R	Zero range	
		00100011	35	R/W	T_TRGT	Total target	
		00100100	36	R/W	TON_HR	Flow rate	
		00100101	37	R/W	S_QTY	Sampling Quantity	
		00100110	38	R/W	GAT_CH	Gate position check	
		00100111 00111111	39 63	Not used			
		01000000	64	R/W	Filter ⁽¹⁾	Refer to par. [120] on page 53	
		01000001	65	Not used			
		01000010	66	R/W	Zeroing Range ⁽¹⁾	Refer to par. [203] on page 54	
		01000011	67	R/W	Auto Zero Tracking ⁽¹⁾	Refer to par. [204] on page 54	
		01000100	68	Not used			
		01000101	69	R/W	Motion Detector ⁽¹⁾	Refer to par. [206] on page 54	
		01000110 01000111	70 71	Not used			
		01001000	72	R/W	Capacity ⁽¹⁾	Refer to par. [212] on page 54	
		01001001	73	R/W	Decimal point ⁽¹⁾	0	XXXX00
						1	XXXXX0
						2	XXXXXX
						3	XXXXX.X
						4	XXXX.XX
		01001010	74	R/W	Increment ⁽¹⁾	1	X1
						2	X2
						3	X5
		01001011 01100000	75 96	Not Used			
		01100001	97	R/W	Feeding type ⁽¹⁾	Refer to par. [501] on page 58	
		01100010	98	R/W	Preact correction factor ⁽¹⁾	Refer to par. [502] on page 58	
		01100011	99	R/W	Not used		
01100100	100	R/W	Check delay ⁽¹⁾	Refer to par. [504] on page 59			
01100101	101	R/W	Zeroing period ⁽¹⁾	Refer to par. [505] on page 59			
01100110	102	R/W	Zeroing delay ⁽¹⁾	Refer to par. [506] on page 59			
01100111	103	R/W	Ind. at the end of filling ⁽¹⁾	Refer to par. [507] on page 59			
01101000	104	R/W	Feeding check time ⁽¹⁾	Refer to par. [508] on page 59			
01101001	105	R/W	Maximum filling weight ⁽¹⁾	Refer to par. [509] on page 59			

Table 14-3 - Expanded Command List

(1) Write this command after writing values to 1st Dword then apply this command with New CMD

Programming steps of frequent used

Reading a weight value:

1. Check the D11...D15 bits of 'BX14 Output to PLC Input 2nd Dword'.
2. If there is not any error, read a weight value (gross, net or tare),

Zero Calibration procedure:

1. Check the low byte of Calibration Status. it should be decimal '1' to start adjustment.
2. Write 'Adjust Zero Calibration' command and apply New CMD to start Zero calibration.
3. Check the low byte of Calibration Status. it is decimal '3' during zero calibration process.
4. The low byte of Calibration Status changes to decimal '1' at the end of the Zero calibration.
5. If the low byte of Calibration Status is '9', check the high byte of Calibration Status to understand the calibration error.

Span Calibration procedure:

1. Check the low byte of Calibration Status. it should be decimal '1' to start adjustment.
2. Write 'Adjust Span Calibration' command after writing test weight values to 1st Dword, then apply this command with New CMD to start Span calibration.
3. Check the low byte of Calibration Status. it is decimal '4' during span calibration process.
4. The low byte of Calibration Status changes to decimal '1' at the end of the Span calibration.
5. If the low byte of Calibration Status is '9', check the high byte of Calibration Status to understand the calibration error.

15. ETHERCAT (ONLY BX14 EC)

EtherCAT interface of the weighing instrument can be done via hub switch or serial bus over two EtherCAT port.

1. Serial bus connection of instruments. You may connect instruments serial to your EtherCAT bus via two ports.
2. Star connection. If you connect the instrument to your PLC via hub switch, you can use P1 port on the instrument.

The EtherCAT interface supports 100Mbit, full duplex operation. ESI file for two port EtherCAT is available in CD which is supplied together with the instrument.

There are 4 announcement LEDs on the instrument to indicate the interface status as seen below. The meanings of these LED's are;

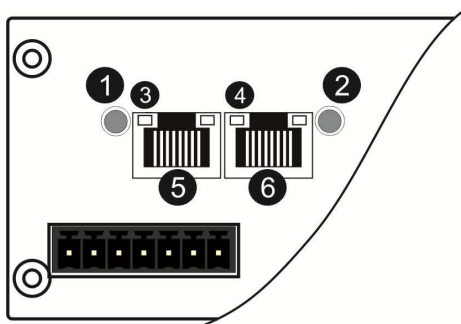

1	NS RUN LED
2	MS ERR LED
3	Link/Activity (IN port)
4	Link/Activity (OUT port)
5	EtherCAT (IN port)
6	EtherCAT (OUT port)

NS RUN LED

LED State	Description
Off	INIT
Green	OPERATIONAL
Green, blinking	PRE-OPERATIONAL
Green, single flash	SAFE-OPERATIONAL
Red	(Fatal Event)

MS ERR LED

LED State	Description
Off	No error (or no power)
Red, blinking	Invalid configuration; State change received from master is not possible due to invalid register or object settings.
Red, single flash	Unsolicited state change; Slave device application has changed the EtherCAT state autonomously.
Red, double flash	Application watchdog timeout
Red	Application controller failure

In the case of red LED warning, check cabling and configuration before reenergizing the instrument after 30 seconds power off.

LINK/Activity LED

LED State	Description
Off	No link, no activity
Green	Link sensed, no activity
Green, flickering	Link sensed, activity

15.1 Data Format

Data format of weight value can be programmable for Floating point (IEEE 754) or Integer. Refer to parameter [060].

15.2 ESI Configuration

EtherCAT data structures of BX14 includes 2 x Input 2 words and 2 x Output 2 words. ESI configuration for PLC programmers is shown in Figure 15.1.

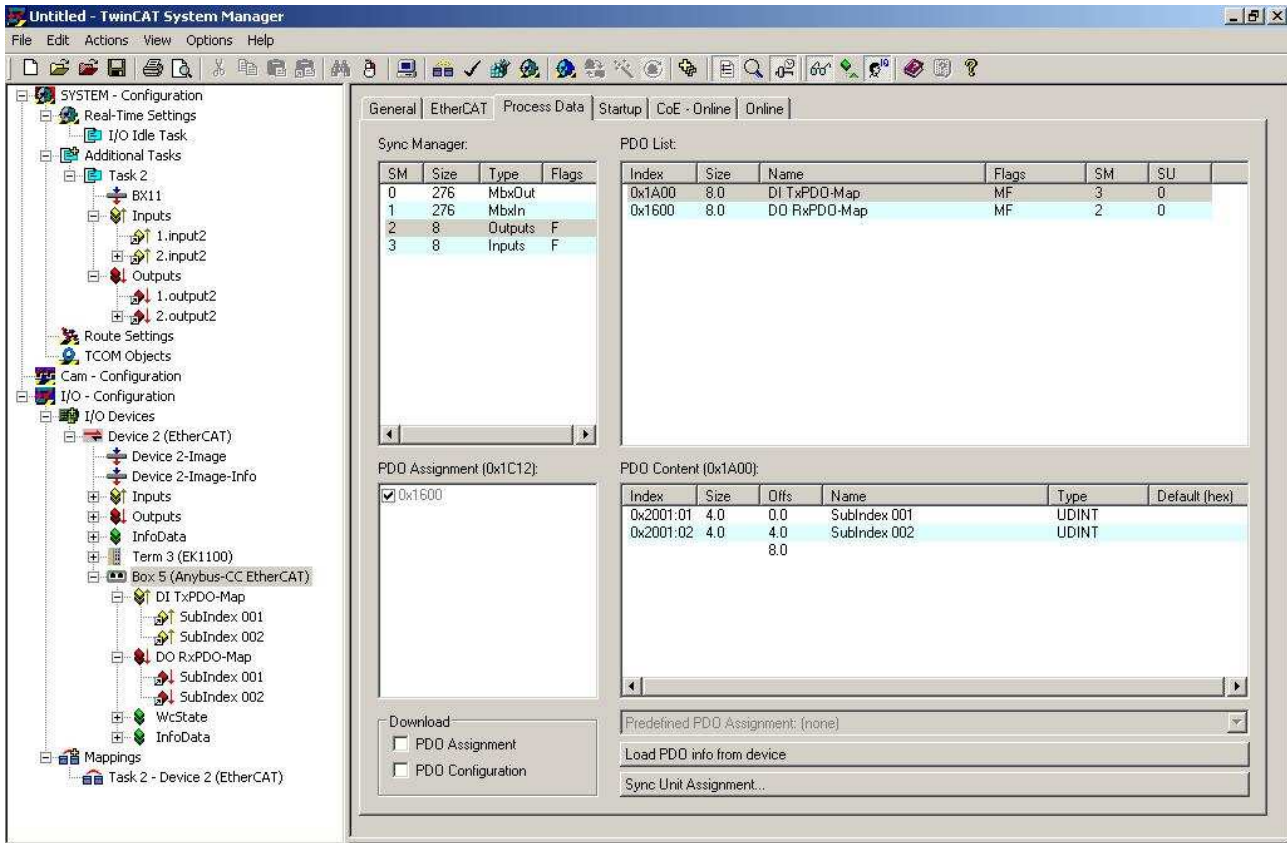

Figure 15.1 – Configuration of module properties for Beckhoff

Input/Output	Definition	Description
DI TxPDO-Map	SubIndex 001	1 st Dword (BX14 Output to PLC Input)
	SubIndex 002	2 nd Dword (BX14 Output to PLC Input)
DO RxPDO-Map	SubIndex 001	1 st Dword (PLC Output to BX14 Input)
	SubIndex 002	2 nd Dword (PLC Output to BX14 Input)

15.3 EtherCAT Data Structure

BX14 Output to PLC Input

Bitwise of a Dword:

Dword (Only read)	D31	D30	D29	D28	D27	D26	D25	D24	D23	D22	D21	D20	D19	D18	D17	D16
	D15	D14	D13	D12	D11	D10	D9	D8	D7	D6	D5	D4	D3	D2	D1	D0

1 st Dword	By default, Actual weight value is represented. To represent other weight or calibration status, refer to next Dword.															
2 nd Dword				Out 5	Out 4	Out 3	Out 2	Out 1	By- Pass	Pipe is clog.			In 4	In 3	In 2	In 1
	Error codes of BX14					Process Error		Centre of zero	Gross Net	MD	Read command response					Cmd Flg

BX14 Output to PLC Input 2nd Dword

Bit Number	2 nd Dword Description			
D31 ... D24	Outputs	Output bit status (Active = 1)		
D23 ... D16	Inputs	Input bit status (Active = 1)		
D15 ... D12	Error Codes of BX14	Bin	Dec	Descriptions
		0000	0	No error found
		0001	1	ADC out
		0010	2	ADC over
		0011	3	ADC under
		0100	4	System Error
		0101	5	In programming mode
		0110	6	Low/High Voltage Error
D11	Not in use			
D10	Process Error	0	No error	
		1	Process error (Check the 'Process error messages')	
D9	Not in use			
D8	Centre of zero	0	Weight is out of zero range	
		1	Weight is in zero range	
D7	Indication	0	Gross	
		1	Net	
D6	MD – Motion Detection	0	Stable	
		1	Dynamic	
D5 ... D1	Read Command Response	00000	0	Actual weight (Net if the indication is in Net)
		00001	1	Gross weight
		00010	2	Tare weight
		00011	3	Calibration Status (Refer to Table 15-2)
		00100	4	Not used
		01110	14	

D5 ... D1	Read Command Response (continuation of previous page)	01111	15	Total-3 (Non-erasable total)
		10000	16	Not used
		10001	17	Target value
		10010	18	Not used
		10011	19	Coarse value
		10100	20	Not used
		10101	21	Fine value
		10110	22	Label number (CN) (Always integer)
		10111	23	Last filling value
		11000	24	Quantity (Always integer)
		11001	25	Total-1 (Erasable total)
		11010	26	Total-2 (The current day's total)
		11011	27	Total-4 (Yesterday's total)
		11100	28	Ton / hour indication (The actual flow rate)
		11101	29	24 hours indication (Estimated daily total)
11110	30	Process error messages (Refer to Table 15-1)		
	11111	31	Use the Expanded Command list (Refer to Table 15-3)	
D0	CMD Flag	Toggles	The command is applied successfully	

Process error messages (always 32 bit integer)

1st Dword descriptions when read command is 'Process error messages'. Refer to 2nd Dword of PLC Output to BX14 Input.

Bit Number	1 st Dword Description			
D31 ... D16	Not in use			
D15 ... D8	Process State	Bin	Dec	Process state
		00000000	0	No process (Adc out, Over, Under etc.)
		00000001	1	Ready
		00000010	2	In filling process
		00000011	3	End of filling (FULL)
		00000100	4	In discharging process
		00000101	5	Delay of flow rate control ([d_tonh] message)
D7 ... D0	Process warning Messages	Bin	Dec	Messages
		00000000	0	No process error
		00000001	1	END
		00000010	2	BY-PASS
		00000011	3	NO FEED
	Process error Messages	00000100	4	RESET
		10000000	128	E GATE
		10000001	129	Not used
		10000111	135	
	10001000	136	E FEED	

Table 15-1– Process error messages

Calibration Status (always 32 bit integer)

1st Dword descriptions when read command is 'Calibration Status'. Refer to 2nd Dword of PLC Output to BX14 Input.

Bit Number	1 st Dword Description			
D31 ... D16	Not in use			
D15 ... D8	Calibration Errors	Bin	Dec	Commands
		0000 0001	1	Calibration Timeout - Restart calibration
		0000 0010	2	ADC Error - Re-energize the instrument
		0000 0011	3	Instrument cannot be calibrating - Check load cell cable - Re-energize the instrument
		0010 0010	34	Instrument cannot be calibrating - Load cell signal is very low or too high
		0010 0011	35	Calibration Error - Calibration loading is not enough - Check test weight loading (Write test weight value to 1 st Dword of PLC Output to BX14 Input then restart the calibration) - Check load cell connections
		0010 0100	36	Calibration load value entry Error - Test weight is too small. Increase the test weight
		0010 0101	37	Scale unstable - Wait until scale become stable - Check grounding wiring
		0010 0110	38	The Calibration DIP switch is not 'On' position. - Check the calibration DIP switch.
D7 ... D0	Calibration Process Status	0000 0001	1	System ready for calibration
		0000 0011	3	Zero calibration in process
		0000 0100	4	Span calibration in process
		0000 1001	9	Error (Refer to Calibration Errors)

Table 15-2 - Calibration status

PLC Output to BX14 Input

Bitwise of a Dword:

Dword (R/W)	D31	D30	D29	D28	D27	D26	D25	D24	D23	D22	D21	D20	D19	D18	D17	D16
	D15	D14	D13	D12	D11	D10	D9	D8	D7	D6	D5	D4	D3	D2	D1	D0

1 st Dword	Next Dword defines the usage of this Dword.															
2 nd Dword	Not used	SFE	Reset	Filling Start	BY-PASS	Not used	Expanded Commands List									
	Not in use				Command List				Read Data Selection				New CMD			

PLC Output to BX14 Input 2nd Dword

Bit Number	2 nd Dword descriptions				
D31 ... D30	Not used				
D29	Start for emptying (SFE)	A transition from 0 to 1 activates the "Start for emptying" command.			
D28	Reset	A transition from 0 to 1 activates the "Reset" command.			
D27	Start for filling	A transition from 0 to 1 activates the "Start for filling" command.			
D26	By-Pass	A transition from 0 to 1 activates the by-pass function and transition from 1 to 0 deactivates the by-pass function.			
D25 ... D24	Not used				
D23 ... D16	Expanded Commands List (Refer to Table 15-3)				
D15 ... D11	Not in use				
D10 ... D6	Command List	Bin	Dec	Commands	
		00000	0	None command is activated	
		00001	1	Zero	
		00010	2	Tare	
		00011	3	Clear	
		00100	4	Print	
		00101	5	Adjust zero calibration	Calibration
		00110	6	Adjust span calibration ⁽¹⁾	
		00111	7	Total Load Cell Capacity ⁽¹⁾	eCal Coefficients
		01000	8	Average mV/V value ⁽¹⁾	
		01001	9	Dead Load value ⁽¹⁾	
		01010	10	Save the coefficients of eCal	
		01011	11	Not used	
10000	16				

D10 ... D6	Command List (continuation of previous page)	10001	17	Target value ^[1]
		10010	18	Not used
		10011	19	Coarse value ^[1]
		10100	20	Not used
		10101	21	Fine value ^[1]
		10110	22	Label number (CN) (Always integer) ^[1]
		10111	23	Not used
		11000	24	Quantity (Always integer) ^[1]
		11001	25	Total-1 ^[1] (Erasable total)
		11010 11110	26 30	Not used
		11111	31	Use the Expanded Command list (Refer to Table 15-3)
D5 ... D1	Read Selection Data	00000	0	Actual weight (Net if the indication is in Net)
		00001	1	Gross weight
		00010	2	Tare weight
		00011	3	Calibration Status (Refer to Table 15-2)
		00100 01110	4 14	Not used
		01111	15	Total-3 (Non-erasable total)
		10000	16	Not used
		10001	17	Target value
		10010	18	Not used
		10011	19	Coarse value
		10100	20	Not used
		10101	21	Fine value
		10110	22	Label number (CN) (Always integer)
		10111	23	Last filling value
		11000	24	Quantity (Always integer)
		11001	25	Total-1 (Erasable total)
		11010	26	Total-2 (The current day's total)
		11011	27	Total-4 (Yesterday's total)
		11100	28	Ton / hour indication (The actual flow rate)
		11101	29	24 hours indication (Estimated daily total)
11110	30	Process error messages (Refer to Table 15-1)		
11111	31	Use the Expanded Command list (Refer to Table 15-3)		
D0	New CMD	Toggle		Apply commands which are listed in this table

(1) Write this command after writing values to 1st Dword, then apply this command with New CMD

Expanded Command List (always 32 bit integer)

Here 1st Dword is the data receiving from PLC and the “D23 ... D16” bits describes below.

Bit No	Description						
D23...D16	Expanded Commands List	Bin	Dec	Commands			
		00000000	0	R	Voltage of Power Supply	Voltage of power supply is indicated with 0.1 VDC increment.	
		00000001 00011111	1 31	Not in use			
					Application parameters ⁽¹⁾		
		00100000	32	R/W	D_DISC	End of emptying delay	
		00100001	33	R/W	D_GATE	Gate control delay	
		00100010	34	R/W	ZERO_R	Zero range	
		00100011	35	R/W	T_TRGT	Total target	
		00100100	36	R/W	TON_HR	Flow rate	
		00100101	37	R/W	S_QTY	Sampling Quantity	
		00100110	38	R/W	GAT_CH	Gate position check	
		00100111 00111111	39 63	Not used			
		01000000	64	R/W	Filter ⁽¹⁾	Refer to par. [120] on page 53	
		01000001	65	Not used			
		01000010	66	R/W	Zeroing Range ⁽¹⁾	Refer to par. [203] on page 54	
		01000011	67	R/W	Auto Zero Tracking ⁽¹⁾	Refer to par. [204] on page 54	
		01000100	68	Not used			
		01000101	69	R/W	Motion Detector ⁽¹⁾	Refer to par. [206] on page 54	
		01000110 01000111	70 71	Not used			
		01001000	72	R/W	Capacity ⁽¹⁾	Refer to par. [212] on page 54	
		01001001	73	R/W	Decimal point ⁽¹⁾	0	XXXX00
						1	XXXXX0
						2	XXXXXX
						3	XXXXX.X
						4	XXXX.XX
		01001010	74	R/W	Increment ⁽¹⁾	1	X1
						2	X2
						3	X5
		01001011 01100000	75 96	Not Used			
		01100001	97	R/W	Feeding type ⁽¹⁾	Refer to par. [501] on page 58	
		01100010	98	R/W	Preact correction factor ⁽¹⁾	Refer to par. [502] on page 58	
		01100011	99	R/W	Not used		
01100100	100	R/W	Check delay ⁽¹⁾	Refer to par. [504] on page 59			
01100101	101	R/W	Zeroing period ⁽¹⁾	Refer to par. [505] on page 59			
01100110	102	R/W	Zeroing delay ⁽¹⁾	Refer to par. [506] on page 59			
01100111	103	R/W	Ind. at the end of filling ⁽¹⁾	Refer to par. [507] on page 59			
01101000	104	R/W	Feeding check time ⁽¹⁾	Refer to par. [508] on page 59			
01101001	105	R/W	Maximum filling weight ⁽¹⁾	Refer to par. [509] on page 59			

Table 15-3 - Expanded Command List

(1) Write this command after writing values to 1st Dword then apply this command with New CMD

Programming steps of frequent used

Reading a weight value:

1. Check the D11...D15 bits of 'BX14 Output to PLC Input 2nd Dword'.
2. If there is not any error, read a weight value (gross, net or tare),

Zero Calibration procedure:

1. Check the low byte of Calibration Status. it should be decimal '1' to start adjustment.
2. Write 'Adjust Zero Calibration' command and apply New CMD to start Zero calibration.
3. Check the low byte of Calibration Status. it is decimal '3' during zero calibration process.
4. The low byte of Calibration Status changes to decimal '1' at the end of the Zero calibration.
5. If the low byte of Calibration Status is '9', check the high byte of Calibration Status to understand the calibration error.

Span Calibration procedure:

1. Check the low byte of Calibration Status. it should be decimal '1' to start adjustment.
2. Write 'Adjust Span Calibration' command after writing test weight values to 1st Dword, then apply this command with New CMD to start Span calibration.
3. Check the low byte of Calibration Status. it is decimal '4' during span calibration process.
4. The low byte of Calibration Status changes to decimal '1' at the end of the Span calibration.
5. If the low byte of Calibration Status is '9', check the high byte of Calibration Status to understand the calibration error.

16. CC-LINK (ONLY BX14 CC)

After setting related parameters to can communicate with the indicator via CC-Link network. Supported CC-Link version is v1.10 and baud rates are 156 kbps (default), 625 kbps, 2,5 Mbps, 5 Mbps and 10 Mbps.

There are 2 LED's near the CC-Link connector which are;

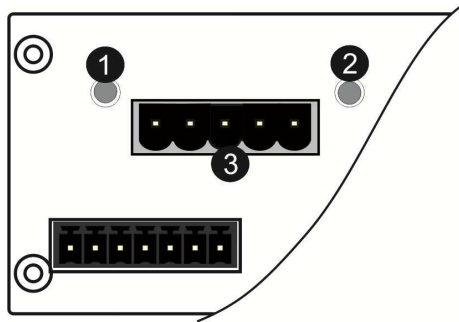

1	NS RUN LED
2	MS ERR LED
3	CC-Link interface

NS Run LED

State	Indication
Off	No network participation, timeout status (no power)
Green	Participating, normal operation
Red	Major fault (FATAL error)

MS Error LED

State	Indication
Off	No error detected (no power)
Red	Major fault (Exception or FATAL event)
Red, flickering	CRC error (temporary flickering)
Red, flashing	Station Number or Baud rate has changed since startup (flashing)

In the case of red LED warning, check cabling and configuration before reenergizing the instrument after 30 seconds power off.

16.1 Data Format

Data format of weight value can be programmable for Floating point (IEEE 754) or Integer. Refer to parameter [070].

16.2 CC-Link Configuration

BX14 has one occupied station area on CC-Link network and station type of BX14 must be programmed as 'Remote device station' in the PLC software. CC-Link configuration for PLC programmers is shown in Figure 16.1.

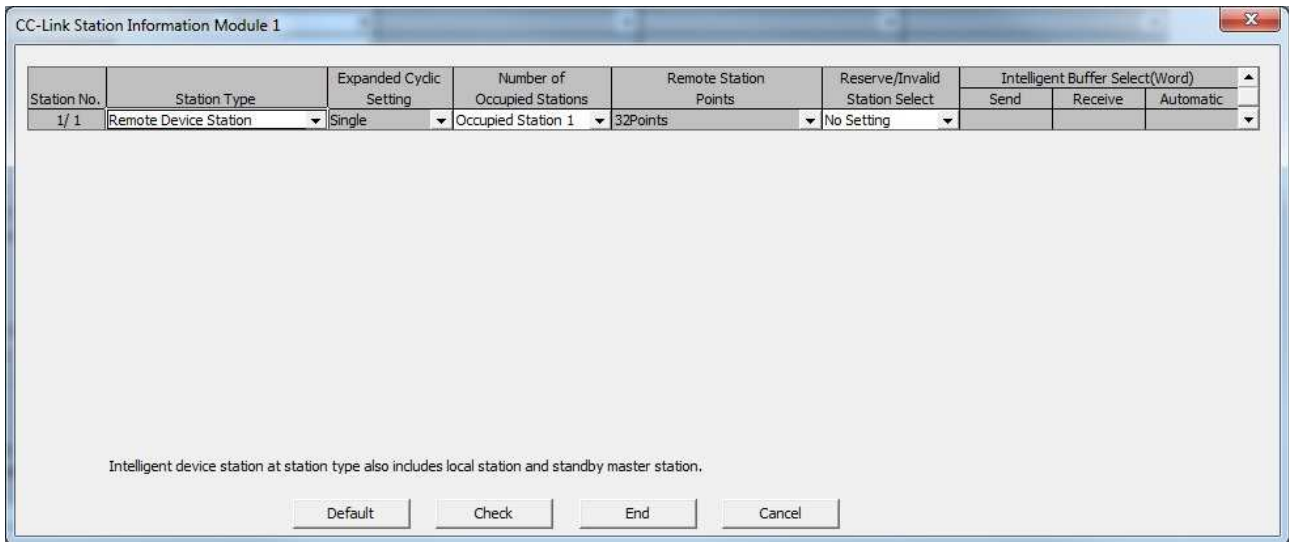

Figure 16.1 – Station information

Input/Output	Definition	Description
Remote Register (RWr)	RWr0, RWr1	1 st Dword Input (<i>BX14 Output to PLC Input</i>)
	RWr2, RWr3	2 nd Dword Input (<i>BX14 Output to PLC Input</i>)
Remote Input (RX)	RX0 ~ RX31	Not used
Remote Register (RWw)	RWw0, RWw1	1 st Dword Output (<i>PLC Output to BX14 Input</i>)
	RWw2, RWw3	2 nd Dword Output (<i>PLC Output to BX14 Input</i>)
Remote Output (RY)	RY0 ~ RY31	Not used

16.4 CC-Link Data Structure

BX14 Output to PLC Input

Bitwise of a Dword:

Dword (Only read)	D31	D30	D29	D28	D27	D26	D25	D24	D23	D22	D21	D20	D19	D18	D17	D16
	D15	D14	D13	D12	D11	D10	D9	D8	D7	D6	D5	D4	D3	D2	D1	D0

1 st Dword Input (RWr0, RWr1)	By default, Indicated weight value is represented. To represent other weight or calibration status, refer to next Dword.															
2 nd Dword Input (RWr2, RWr3)				Out 5	Out 4	Out 3	Out 2	Out 1	By- Pass	Pipe is clog.			In 4	In 3	In 2	In 1
	Error codes of BX14					Process Error		Centre of zero	Gross Net	MD	Read command response					Cmd Flg

BX14 Output to PLC Input 2nd Dword

Bit Number	2 nd Dword Description			
D31 ... D24	Outputs	Output bit status (Active = 1)		
D23 ... D16	Inputs	Input bit status (Active = 1)		
D15 ... D12	Error Codes of BX14	Bin	Dec	Descriptions
		0000	0	No error found
		0001	1	ADC out
		0010	2	ADC over
		0011	3	ADC under
		0100	4	System Error
		0101	5	In programming mode
		0110	6	Low/High Voltage Error
D11	Not in use			
D10	Process Error	0	No error	
		1	Process error (Check the 'Process error messages')	
D9	Not in use			
D8	Centre of zero	0	Weight is out of zero range	
		1	Weight is in zero range	
D7	Indication	0	Gross	
		1	Net	
D6	MD – Motion Detection	0	Stable	
		1	Dynamic	
D5 ... D1	Read Command Response	00000	0	Actual weight (Net if the indication is in Net)
		00001	1	Gross weight
		00010	2	Tare weight
		00011	3	Calibration Status (Refer to Table 16-2)
		00100	4	Not used
		01110	14	

D5 ... D1	Read Command Response (continuation of previous page)	01111	15	Total-3	(Non-erasable total)
		10000	16	Not used	
		10001	17	Target value	
		10010	18	Not used	
		10011	19	Coarse value	
		10100	20	Not used	
		10101	21	Fine value	
		10110	22	Label number (CN)	(Always integer)
		10111	23	Last filling value	
		11000	24	Quantity	(Always integer)
		11001	25	Total-1	(Erasable total)
		11010	26	Total-2	(The current day's total)
		11011	27	Total-4	(Yesterday's total)
		11100	28	Ton / hour indication	(The actual flow rate)
		11101	29	24 hours indication	(Estimated daily total)
11110	30	Process error messages	(Refer to Table 16-1)		
	11111	31	Use the Expanded Command list (Refer to Table 16-3)		
D0	CMD Flag	Toggles		The command is applied successfully	

Process error messages (always 32 bit integer)

1st Dword descriptions when read command is 'Process error messages'. Refer to 2nd Dword of PLC Output to BX14 Input.

Bit Number	1 st Dword Description			
D31 ... D16	Not in use			
D15 ... D8	Process State	Bin	Dec	Process state
		00000000	0	No process (Adc out, Over, Under etc.)
		00000001	1	Ready
		00000010	2	In filling process
		00000011	3	End of filling (FULL)
		00000100	4	In discharging process
		00000101	5	Delay of flow rate control ([d_tonh] message)
D7 ... D0	Process warning Messages	Bin	Dec	Messages
		00000000	0	No process error
		00000001	1	END
		00000010	2	BY-PASS
		00000011	3	NO FEED
	Process error Messages	00000100	4	RESET
		10000000	128	E GATE
		10000001	129	Not used
		10000111	135	
	10001000	136	E FEED	

Table 16-1– Process error messages

Calibration Status (always 32 bit integer)

1st Dword descriptions when read command is 'Calibration Status'. Refer to 2nd Dword of PLC Output to BX14 Input.

Bit Number	1 st Dword Description			
D31 ... D16	Not in use			
D15 ... D8	Calibration Errors	Bin	Dec	Commands
		0000 0001	1	Calibration Timeout - Restart calibration
		0000 0010	2	ADC Error - Re-energize the instrument
		0000 0011	3	Instrument cannot be calibrating - Check load cell cable - Re-energize the instrument
		0010 0010	34	Instrument cannot be calibrating - Load cell signal is very low or too high
		0010 0011	35	Calibration Error - Calibration loading is not enough - Check test weight loading (Write test weight value to 1 st Dword of PLC Output to BX14 Input then restart the calibration) - Check load cell connections
		0010 0100	36	Calibration load value entry Error - Test weight is too small. Increase the test weight
		0010 0101	37	Scale unstable - Wait until scale become stable - Check grounding wiring
		0010 0110	38	The Calibration DIP switch is not 'On' position. - Check the calibration DIP switch.
D7 ... D0	Calibration Process Status	0000 0001	1	System ready for calibration
		0000 0011	3	Zero calibration in process
		0000 0100	4	Span calibration in process
		0000 1001	9	Error (Refer to Calibration Errors)

Table 16-2 - Calibration status

PLC Output to BX14 Input

Bitwise of a Dword:

Dword (R/W)	D31	D30	D29	D28	D27	D26	D25	D24	D23	D22	D21	D20	D19	D18	D17	D16
	D15	D14	D13	D12	D11	D10	D9	D8	D7	D6	D5	D4	D3	D2	D1	D0

1 st Dword Output (RWw0, RWw1)	Next Dword defines the usage of this Dword.															
2 nd Dword Output (RWw2, RWw3)	Not used	SFE	Reset	Filling Start	BY- PASS	Not used	Expanded Commands List									
	Not in use				Command List				Read Data Selection				New CMD			

PLC Output to BX14 Input 2nd Dword

Bit Number	2 nd Dword descriptions				
D31 ... D30	Not used				
D29	Start for emptying (SFE)	A transition form 0 to1 activates the "Start for emptying" command.			
D28	Reset	A transition form 0 to1 activates the "Reset" command.			
D27	Start for filling	A transition form 0 to1 activates the "Start for filling" command.			
D26	By-Pass	A transition from 0 to1 activates the by-pass function and transition from 1 to 0 deactivates the by-pass function.			
D25 ... D24	Not used				
D23 ... D16	Expanded Commands List (Refer to Table 16-3)				
D15 ... D11	Not in use				
D10 ... D6	Command List	Bin	Dec	Commands	
		00000	0	None command is activated	
		00001	1	Zero	
		00010	2	Tare	
		00011	3	Clear	
		00100	4	Print	
		00101	5	Adjust zero calibration	Calibration
		00110	6	Adjust span calibration ⁽¹⁾	
		00111	7	Total Load Cell Capacity ⁽¹⁾	eCal Coefficients
		01000	8	Average mV/V value ⁽¹⁾	
		01001	9	Dead Load value ⁽¹⁾	
		01010	10	Save the coefficients of eCal	Refer to par. [313]
		01011	11	Not used	
10000	16	Not used			

D10 ... D6	Command List (continuation of previous page)	10001	17	Target value ^[1]
		10010	18	Not used
		10011	19	Coarse value ^[1]
		10100	20	Not used
		10101	21	Fine value ^[1]
		10110	22	Label number (CN) (Always integer) ^[1]
		10111	23	Not used
		11000	24	Quantity (Always integer) ^[1]
		11001	25	Total-1 ^[1] (Erasable total)
		11010 11110	26 30	Not used
		11111	31	Use the Expanded Command list (Refer to Table 16-3)
D5 ... D1	Read Selection Data	00000	0	Actual weight (Net if the indication is in Net)
		00001	1	Gross weight
		00010	2	Tare weight
		00011	3	Calibration Status (Refer to Table 16-2)
		00100 01110	4 14	Not used
		01111	15	Total-3 (Non-erasable total)
		10000	16	Not used
		10001	17	Target value
		10010	18	Not used
		10011	19	Coarse value
		10100	20	Not used
		10101	21	Fine value
		10110	22	Label number (CN) (Always integer)
		10111	23	Last filling value
		11000	24	Quantity (Always integer)
		11001	25	Total-1 (Erasable total)
		11010	26	Total-2 (The current day's total)
		11011	27	Total-4 (Yesterday's total)
		11100	28	Ton / hour indication (The actual flow rate)
		11101	29	24 hours indication (Estimated daily total)
11110	30	Process error messages (Refer to Table 16-1)		
11111	31	Use the Expanded Command list (Refer to Table 16-3)		
D0	New CMD	Toggle		Apply commands which are listed in this table

(1) Write this command after writing values to 1st Dword, then apply this command with New CMD

Expanded Command List (always 32 bit integer)

Here 1st Dword is the data receiving from PLC and the “D23 ... D16” bits describes below.

Bit No	Description						
D23...D16	Expanded Commands List	Bin	Dec	Commands			
		00000000	0	R	Voltage of Power Supply	Voltage of power supply is indicated with 0.1 VDC increment.	
		00000001 00011111	1 31	Not in use			
					Application parameters ⁽¹⁾		
		00100000	32	R/W	D_DISC	End of emptying delay	
		00100001	33	R/W	D_GATE	Gate control delay	
		00100010	34	R/W	ZERO_R	Zero range	
		00100011	35	R/W	T_TRGT	Total target	
		00100100	36	R/W	TON_HR	Flow rate	
		00100101	37	R/W	S_QTY	Sampling Quantity	
		00100110	38	R/W	GAT_CH	Gate position check	
		00100111 00111111	39 63	Not used			
		01000000	64	R/W	Filter ⁽¹⁾	Refer to par. [120] on page 53	
		01000001	65	Not used			
		01000010	66	R/W	Zeroing Range ⁽¹⁾	Refer to par. [203] on page 54	
		01000011	67	R/W	Auto Zero Tracking ⁽¹⁾	Refer to par. [204] on page 54	
		01000100	68	Not used			
		01000101	69	R/W	Motion Detector ⁽¹⁾	Refer to par. [206] on page 54	
		01000110 01000111	70 71	Not used			
		01001000	72	R/W	Capacity ⁽¹⁾	Refer to par. [212] on page 54	
		01001001	73	R/W	Decimal point ⁽¹⁾	0	XXXX00
						1	XXXXX0
						2	XXXXXX
						3	XXXXX.X
						4	XXXX.XX
						5	XXX.XXX
		01001010	74	R/W	Increment ⁽¹⁾	1	X1
						2	X2
						3	X5
		01001011 01100000	75 96	Not Used			
		01100001	97	R/W	Feeding type ⁽¹⁾	Refer to par. [501] on page 58	
		01100010	98	R/W	Preact correction factor ⁽¹⁾	Refer to par. [502] on page 58	
01100011	99	R/W	Not used				
01100100	100	R/W	Check delay ⁽¹⁾	Refer to par. [504] on page 59			
01100101	101	R/W	Zeroing period ⁽¹⁾	Refer to par. [505] on page 59			
01100110	102	R/W	Zeroing delay ⁽¹⁾	Refer to par. [506] on page 59			
01100111	103	R/W	Ind. at the end of filling ⁽¹⁾	Refer to par. [507] on page 59			
01101000	104	R/W	Feeding check time ⁽¹⁾	Refer to par. [508] on page 59			
01101001	105	R/W	Maximum filling weight ⁽¹⁾	Refer to par. [509] on page 59			

Table 16-3 - Expanded Command List

(1) Write this command after writing values to 1st Dword then apply this command with New CMD

Programming steps of frequent used

Reading a weight value:

1. Check the D11...D15 bits of 'BX14 Output to PLC Input 2nd Dword'.
2. If there is not any error, read a weight value (gross, net or tare),

Zero Calibration procedure:

1. Check the low byte of Calibration Status. it should be decimal '1' to start adjustment.
2. Write 'Adjust Zero Calibration' command and apply New CMD to start Zero calibration.
3. Check the low byte of Calibration Status. it is decimal '3' during zero calibration process.
4. The low byte of Calibration Status changes to decimal '1' at the end of the Zero calibration.
5. If the low byte of Calibration Status is '9', check the high byte of Calibration Status to understand the calibration error.

Span Calibration procedure:

1. Check the low byte of Calibration Status. it should be decimal '1' to start adjustment.
2. Write 'Adjust Span Calibration' command after writing test weight values to 1st Dword, then apply this command with New CMD to start Span calibration.
3. Check the low byte of Calibration Status. it is decimal '4' during span calibration process.
4. The low byte of Calibration Status changes to decimal '1' at the end of the Span calibration.
5. If the low byte of Calibration Status is '9', check the high byte of Calibration Status to understand the calibration error.

17. POWERLINK (ONLY BX14 PL)

Powerlink interface of the weighing instrument can be done via hub switch or serial bus over two Powerlink port.

1. Serial bus connection of instruments. You may connect instruments serial to your Powerlink bus via two ports.
2. Star connection. If you connect the instrument to your PLC via hub switch, you can use P1 or P2 port on the instrument. You may change the port, if there is any malfunction on port in usage.

The Powerlink interface is 100Mbit and half duplex. XDD file for two port Powerlink is available in CD which is supplied together with the instrument.

There are 4 announcement LEDs on the instrument to indicate the interface status as seen below. The meanings of these LED's are;

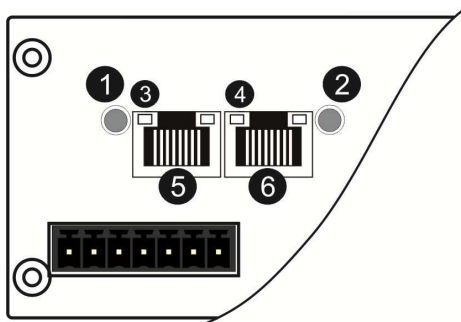

1	STS Status LED
2	Err Error LED
3	Link/Activity LED (port 1)
4	Link/Activity LED (port 2)
5	P1 interface (port 1)
6	P2 interface (port 2)

STS Status LED

LED State	Description
Off	Module is off, initializing, or not active.
Green, fast flashing ^a	NMT_CS_BASIC_ETHERNET Basic Ethernet state: no POWERLINK traffic has been detected.
Green, single flash	NMT_CS_PRE_OPERATIONAL_1. Only asynchronous data.
Green, double flash	NMT_CS_PRE_OPERATIONAL_2. Asynchronous and synchronous data. No PDO data. ^b
Green, triple flash	NMT_CS_READY_TO_OPERATE. Ready to operate. Asynchronous and synchronous data. No PDO data. ^b
Green	NMT_CS_OPERATIONAL. Fully operational. Asynchronous and synchronous data. PDO data is sent and received.
Green, slow flashing ^c	NMT_CS_STOPPED Module stopped (for controlled shutdown, for example). Asynchronous and synchronous data. No PDO data. ^b
Red	If the ERROR LED also is red, a fatal event was encountered.

a. On 50 ms, off 50 ms.

b. Any process data sent is declared not valid and received process data must be ignored in this state.

c. On 200 ms, off 200 ms.

Err Error LED

LED State	Description
Off	No error
Red	If the STATUS LED is not red, a non-fatal error has been detected. If the STATUS LED is red, a fatal event was encountered.

In the case of red LED warning, check cabling and configuration before reenergizing the instrument after 30 seconds power off.

LINK/Activity LED

LED State	Description
Off	No link.
Green	Link, no traffic.
Green, flashing	Link and traffic.

17.1 Data Format

Data format of weight value can be programmable for Floating point (IEEE 754) or Integer. Refer to parameter [070].

17.2 XDD Configuration

Powerlink data structures consist of 2 pcs Input-2 words and 2 pcs Output-2 words. XDD configuration for PLC programmers is shown in Figure 17.1.

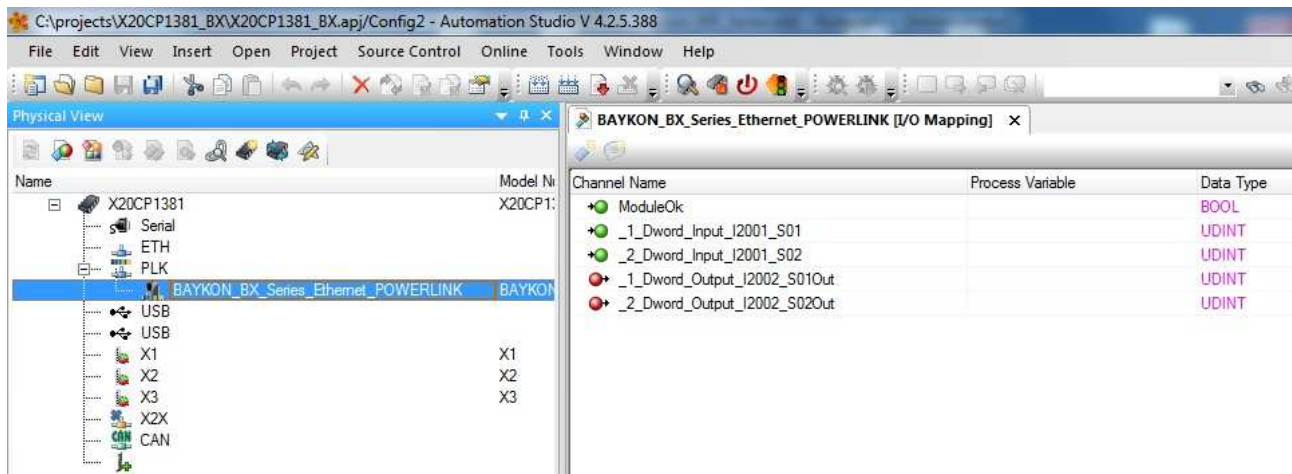

Figure 17.1 – Configuration of module properties with XDD file

Data Length	Description
1_Dword_Input_I2001_S01	1 st Dword (BX14 PL Output to PLC Input)
2_Dword_Input_I2001_S02	2 nd Dword (BX14 PL Output to PLC Input)
1_Dword_Output_I2002_S01Out	1 st Dword (PLC Output to BX14 PL Input)
2_Dword_Output_I2002_S02Out	2 nd Dword (PLC Output to BX14 PL Input)

17.3 Powerlink Data Structure

BX14 Output to PLC Input

Bitwise of a Dword:

Dword (Only read)	D31	D30	D29	D28	D27	D26	D25	D24	D23	D22	D21	D20	D19	D18	D17	D16
	D15	D14	D13	D12	D11	D10	D9	D8	D7	D6	D5	D4	D3	D2	D1	D0

1 st Dword	By default, Actual weight value is represented. To represent other weight or calibration status, refer to next Dword.															
2 nd Dword				Out 5	Out 4	Out 3	Out 2	Out 1	By- Pass	Pipe is clog.			In 4	In 3	In 2	In 1
	Error codes of BX14					Process Error		Centre of zero	Gross Net	MD	Read command response					Cmd Flg

BX14 Output to PLC Input 2nd Dword

Bit Number	2 nd Dword Description			
D31 ... D24	Outputs	Output bit status (Active = 1)		
D23 ... D16	Inputs	Input bit status (Active = 1)		
D15 ... D12	Error Codes of BX14	Bin	Dec	Descriptions
		0000	0	No error found
		0001	1	ADC out
		0010	2	ADC over
		0011	3	ADC under
		0100	4	System Error
		0101	5	In programming mode
		0110	6	Low/High Voltage Error
D11	Not in use			
D10	Process Error	0	No error	
		1	Process error (Check the 'Process error messages')	
D9	Not in use			
D8	Centre of zero	0	Weight is out of zero range	
		1	Weight is in zero range	
D7	Indication	0	Gross	
		1	Net	
D6	MD – Motion Detection	0	Stable	
		1	Dynamic	
D5 ... D1	Read Command Response	00000	0	Actual weight (Net if the indication is in Net)
		00001	1	Gross weight
		00010	2	Tare weight
		00011	3	Calibration Status (Refer to Table 17-2)
		00100	4	Not used
		01110	14	

D5 ... D1	Read Command Response (continuation of previous page)	01111	15	Total-3	(Non-erasable total)
		10000	16	Not used	
		10001	17	Target value	
		10010	18	Not used	
		10011	19	Coarse value	
		10100	20	Not used	
		10101	21	Fine value	
		10110	22	Label number (CN)	(Always integer)
		10111	23	Last filling value	
		11000	24	Quantity	(Always integer)
		11001	25	Total-1	(Erasable total)
		11010	26	Total-2	(The current day's total)
		11011	27	Total-4	(Yesterday's total)
		11100	28	Ton / hour indication	(The actual flow rate)
		11101	29	24 hours indication	(Estimated daily total)
11110	30	Process error messages	(Refer to Table 17-1)		
	11111	31	Use the Expanded Command list (Refer to Table 17-3)		
D0	CMD Flag	Toggles		The command is applied successfully	

Process error messages (always 32 bit integer)

1st Dword descriptions when read command is 'Process error messages'. Refer to 2nd Dword of PLC Output to BX14 Input.

Bit Number	1 st Dword Description			
D31 ... D16	Not in use			
D15 ... D8	Process State	Bin	Dec	Process state
		00000000	0	No process (Adc out, Over, Under etc.)
		00000001	1	Ready
		00000010	2	In filling process
		00000011	3	End of filling (FULL)
		00000100	4	In discharging process
		00000101	5	Delay of flow rate control ([d_tonh] message)
D7 ... D0	Process warning Messages	Bin	Dec	Messages
		00000000	0	No process error
		00000001	1	END
		00000010	2	BY-PASS
		00000011	3	NO FEED
	Process error Messages	00000100	4	RESET
		10000000	128	E GATE
		10000001	129	Not used
		10000111	135	
	10001000	136	E FEED	

Table 17-1– Process error messages

Calibration Status (always 32 bit integer)

1st Dword descriptions when read command is 'Calibration Status'. Refer to 2nd Dword of PLC Output to BX14 Input.

Bit Number	1 st Dword Description			
D31 ... D16	Not in use			
D15 ... D8	Calibration Errors	Bin	Dec	Commands
		0000 0001	1	Calibration Timeout - Restart calibration
		0000 0010	2	ADC Error - Re-energize the instrument
		0000 0011	3	Instrument cannot be calibrating - Check load cell cable - Re-energize the instrument
		0010 0010	34	Instrument cannot be calibrating - Load cell signal is very low or too high
		0010 0011	35	Calibration Error - Calibration loading is not enough - Check test weight loading (Write test weight value to 1 st Dword of PLC Output to BX14 Input then restart the calibration) - Check load cell connections
		0010 0100	36	Calibration load value entry Error - Test weight is too small. Increase the test weight
		0010 0101	37	Scale unstable - Wait until scale become stable - Check grounding wiring
		0010 0110	38	The Calibration DIP switch is not 'On' position. - Check the calibration DIP switch.
D7 ... D0	Calibration Process Status	0000 0001	1	System ready for calibration
		0000 0011	3	Zero calibration in process
		0000 0100	4	Span calibration in process
		0000 1001	9	Error (Refer to Calibration Errors)

Table 17-2 - Calibration status

PLC Output to BX14 Input

Bitwise of a Dword:

Dword (R/W)	D31	D30	D29	D28	D27	D26	D25	D24	D23	D22	D21	D20	D19	D18	D17	D16
	D15	D14	D13	D12	D11	D10	D9	D8	D7	D6	D5	D4	D3	D2	D1	D0

1 st Dword	Next Dword defines the usage of this Dword.															
2 nd Dword	Not used	SFE	Reset	Filling Start	BY- PASS	Not used	Expanded Commands List									
	Not in use				Command List				Read Data Selection				New CMD			

PLC Output to BX14 Input 2nd Dword

Bit Number	2 nd Dword descriptions				
D31 ... D30	Not used				
D29	Start for emptying (SFE)	A transition from 0 to 1 activates the "Start for emptying" command.			
D28	Reset	A transition from 0 to 1 activates the "Reset" command.			
D27	Start for filling	A transition from 0 to 1 activates the "Start for filling" command.			
D26	By-Pass	A transition from 0 to 1 activates the by-pass function and transition from 1 to 0 deactivates the by-pass function.			
D25 ... D24	Not used				
D23 ... D16	Expanded Commands List (Refer to Table 17-3)				
D15 ... D11	Not in use				
D10 ... D6	Command List	Bin	Dec	Commands	
		00000	0	None command is activated	
		00001	1	Zero	
		00010	2	Tare	
		00011	3	Clear	
		00100	4	Print	
		00101	5	Adjust zero calibration	Calibration
		00110	6	Adjust span calibration ⁽¹⁾	
		00111	7	Total Load Cell Capacity ⁽¹⁾	eCal Coefficients
		01000	8	Average mV/V value ⁽¹⁾	
		01001	9	Dead Load value ⁽¹⁾	
		01010	10	Save the coefficients of eCal	
		01011	11	Not used	
10000	16				

D10 ... D6	Command List (continuation of previous page)	10001	17	Target value ^[1]
		10010	18	Not used
		10011	19	Coarse value ^[1]
		10100	20	Not used
		10101	21	Fine value ^[1]
		10110	22	Label number (CN) (Always integer) ^[1]
		10111	23	Not used
		11000	24	Quantity (Always integer) ^[1]
		11001	25	Total-1 ^[1] (Erasable total)
		11010 11110	26 30	Not used
		11111	31	Use the Expanded Command list (Refer to Table 17-3)
D5 ... D1	Read Selection Data	00000	0	Actual weight (Net if the indication is in Net)
		00001	1	Gross weight
		00010	2	Tare weight
		00011	3	Calibration Status (Refer to Table 17-2)
		00100 01110	4 14	Not used
		01111	15	Total-3 (Non-erasable total)
		10000	16	Not used
		10001	17	Target value
		10010	18	Not used
		10011	19	Coarse value
		10100	20	Not used
		10101	21	Fine value
		10110	22	Label number (CN) (Always integer)
		10111	23	Last filling value
		11000	24	Quantity (Always integer)
		11001	25	Total-1 (Erasable total)
		11010	26	Total-2 (The current day's total)
		11011	27	Total-4 (Yesterday's total)
		11100	28	Ton / hour indication (The actual flow rate)
		11101	29	24 hours indication (Estimated daily total)
11110	30	Process error messages (Refer to Table 17-1)		
11111	31	Use the Expanded Command list (Refer to Table 17-3)		
D0	New CMD	Toggle		Apply commands which are listed in this table

(1) Write this command after writing values to 1st Dword, then apply this command with New CMD

Expanded Command List (always 32 bit integer)

Here 1st Dword is the data receiving from PLC and the “D23 ... D16” bits describes below.

Bit No	Description						
D23...D16	Expanded Commands List	Bin	Dec	Commands			
		00000000	0	R	Voltage of Power Supply	Voltage of power supply is indicated with 0.1 VDC increment.	
		00000001 00011111	1 31	Not in use			
					Application parameters ⁽¹⁾		
		00100000	32	R/W	D_DISC	End of emptying delay	
		00100001	33	R/W	D_GATE	Gate control delay	
		00100010	34	R/W	ZERO_R	Zero range	
		00100011	35	R/W	T_TRGT	Total target	
		00100100	36	R/W	TON_HR	Flow rate	
		00100101	37	R/W	S_QTY	Sampling Quantity	
		00100110	38	R/W	GAT_CH	Gate position check	
		00100111 00111111	39 63	Not used			
		01000000	64	R/W	Filter ⁽¹⁾	Refer to par. [120] on page 53	
		01000001	65	Not used			
		01000010	66	R/W	Zeroing Range ⁽¹⁾	Refer to par. [203] on page 54	
		01000011	67	R/W	Auto Zero Tracking ⁽¹⁾	Refer to par. [204] on page 54	
		01000100	68	Not used			
		01000101	69	R/W	Motion Detector ⁽¹⁾	Refer to par. [206] on page 54	
		01000110 01000111	70 71	Not used			
		01001000	72	R/W	Capacity ⁽¹⁾	Refer to par. [212] on page 54	
		01001001	73	R/W	Decimal point ⁽¹⁾	0	XXXX00
						1	XXXXX0
						2	XXXXXX
						3	XXXXX.X
						4	XXXX.XX
		01001010	74	R/W	Increment ⁽¹⁾	1	X1
						2	X2
						3	X5
		01001011 01100000	75 96	Not Used			
		01100001	97	R/W	Feeding type ⁽¹⁾	Refer to par. [501] on page 58	
		01100010	98	R/W	Preact correction factor ⁽¹⁾	Refer to par. [502] on page 58	
		01100011	99	R/W	Not used		
01100100	100	R/W	Check delay ⁽¹⁾	Refer to par. [504] on page 59			
01100101	101	R/W	Zeroing period ⁽¹⁾	Refer to par. [505] on page 59			
01100110	102	R/W	Zeroing delay ⁽¹⁾	Refer to par. [506] on page 59			
01100111	103	R/W	Ind. at the end of filling ⁽¹⁾	Refer to par. [507] on page 59			
01101000	104	R/W	Feeding check time ⁽¹⁾	Refer to par. [508] on page 59			
01101001	105	R/W	Maximum filling weight ⁽¹⁾	Refer to par. [509] on page 59			

Table 17-3 - Expanded Command List

(1) Write this command after writing values to 1st Dword then apply this command with New CMD

Programming steps of frequent used

Reading a weight value:

1. Check the D11...D15 bits of 'BX14 Output to PLC Input 2nd Dword'.
2. If there is not any error, read a weight value (gross, net or tare),

Zero Calibration procedure:

1. Check the low byte of Calibration Status. it should be decimal '1' to start adjustment.
2. Write 'Adjust Zero Calibration' command and apply New CMD to start Zero calibration.
3. Check the low byte of Calibration Status. it is decimal '3' during zero calibration process.
4. The low byte of Calibration Status changes to decimal '1' at the end of the Zero calibration.
5. If the low byte of Calibration Status is '9', check the high byte of Calibration Status to understand the calibration error.

Span Calibration procedure:

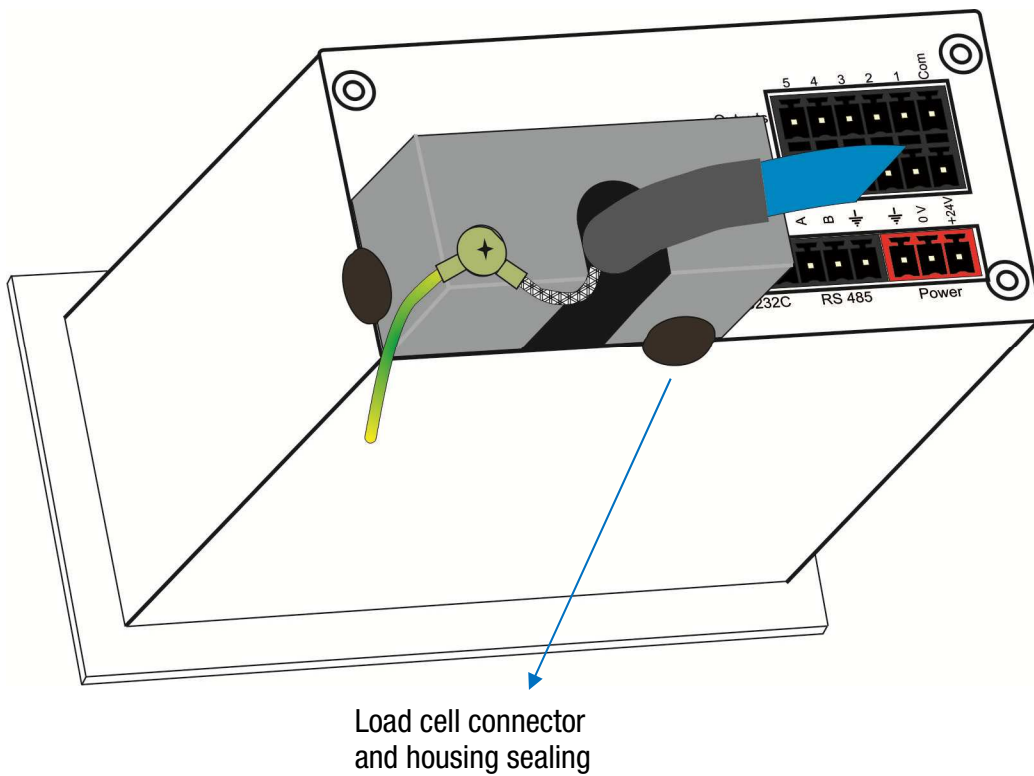
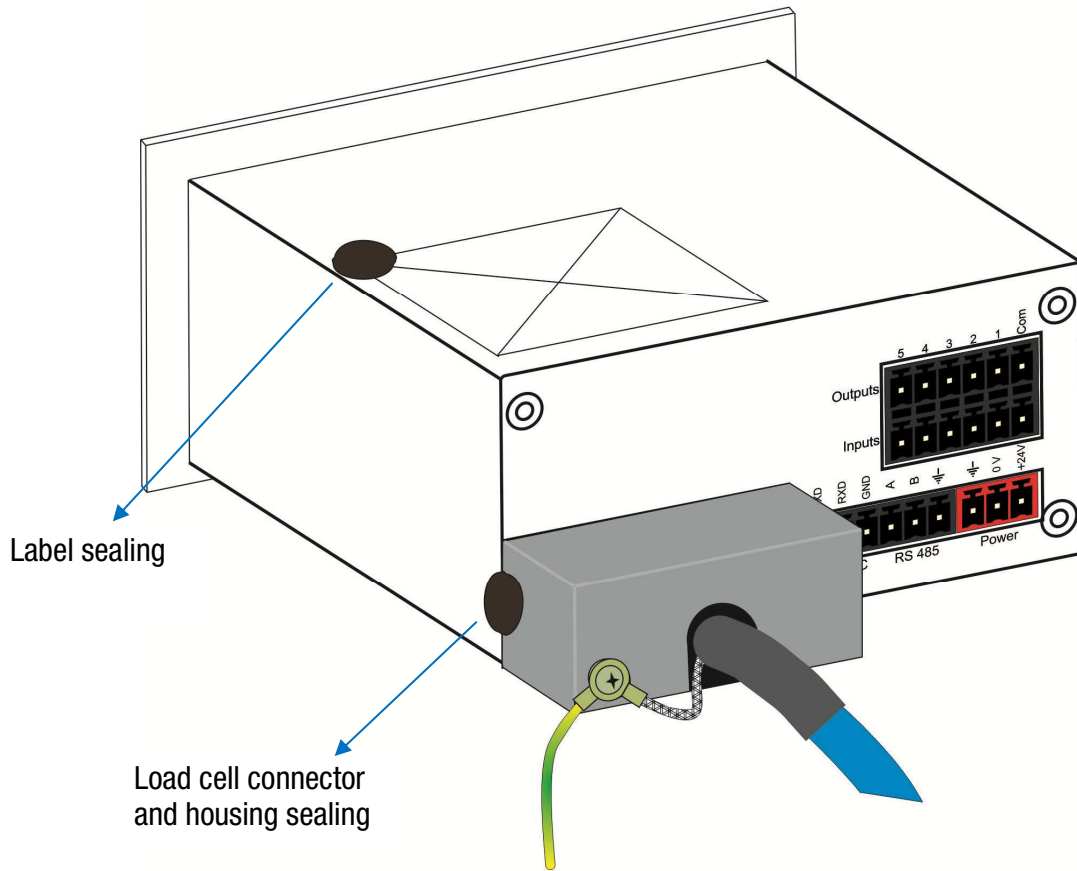

1. Check the low byte of Calibration Status. it should be decimal '1' to start adjustment.
2. Write 'Adjust Span Calibration' command after writing test weight values to 1st Dword, then apply this command with New CMD to start Span calibration.
3. Check the low byte of Calibration Status. it is decimal '4' during span calibration process.
4. The low byte of Calibration Status changes to decimal '1' at the end of the Span calibration.
5. If the low byte of Calibration Status is '9', check the high byte of Calibration Status to understand the calibration error.

18. APPROVED SCALE'S SEALING



19. TROUBLE SHOOTING

BX14 filling controller had been designed as a very reliable and virtually error free instrument. However if there is an error occurs, do not attempt to repair the equipment before understanding what caused the error. Note the problems you have with your instrument and the error messages shown on the display. Then try to solve the problem according to the error table given below.

ERROR CODE	DESCRIPTION	THINGS TO DO
	Weight is too low	<ul style="list-style-type: none"> - Check the load - Load cell or instrument could be broken.
	Over Load	
LC Err	Load exceeds the operation range	<ul style="list-style-type: none"> - Check the load - Check the calibration - Load cell or instrument could be broken.
Err 1	ADC error	<ul style="list-style-type: none"> - Re-energize indicator - Call BAYKON
Err 2	ADC error	<ul style="list-style-type: none"> - Re-energize indicator - Call BAYKON
Err 3	Indicator cannot be calibrating	<ul style="list-style-type: none"> - Check load cell cable and load then start calibration again
Err 10	EEPROM error	<ul style="list-style-type: none"> - Configure the instrument - EEPROM broken
Err 20	Calibration error	<ul style="list-style-type: none"> - Calibrate the indicator..
Err 21	Configuration error	<ul style="list-style-type: none"> - Configure the indicator.
Err 22	Tare, CN, Total weight and the SP in use error	<ul style="list-style-type: none"> - Check SP, PT and ID entries. - Check Tare, CN and Total weight
Err 27	Indicator is not calibrated	<ul style="list-style-type: none"> - Calibrate the indicator
Err 30	Processor Error	<ul style="list-style-type: none"> - Call BAYKON
Err 34	Indicator cannot be calibrating	<ul style="list-style-type: none"> - Load cell signal is negative , very low or too high
Err 35	Calibration Error	<ul style="list-style-type: none"> - Calibration loading is not enough. - Check test weight loading.
Err 36	Calibration load value entry Error	<ul style="list-style-type: none"> - Test weight is too small. Increase the test weight.
Err 37	Scale unstable	<ul style="list-style-type: none"> - Wait until scale become stable. - Check grounding wiring.
Err 47	Main pcb info error	<ul style="list-style-type: none"> - Call BAYKON
Err 61	Eeprom error	<ul style="list-style-type: none"> - Call BAYKON
Err 70	Modbus selection error	<ul style="list-style-type: none"> - Check data format of other interfaces. - Other serial interfaces should not be Modbus.
E XXXX	Hardware error	<ul style="list-style-type: none"> - Call BAYKON

20. PARAMETER'S DEFAULT TABLE

0--	Interface Block	
00-	RS 232C	
000	Data Format	3 = BSI
001	Baud rate	3 = 9600
003	Address	0
004	Data length and Parity	0 = 8 bit, no parity
005	Checksum	0 = Disable
006	Carriage Return	1 = Enable
007	Line Feed	1 = Enable
008	Response Speed	0 = immediately
01-	RS 485	
010	Data Format	5 = Modbus RTU Lo-Hi ⁽¹⁾
011	Baud rate	3 = 9600
013	Address	1
014	Data length and Parity	0 = 8 bit, no parity
015	Checksum	0 = Disable
016	Carriage Return	1 = Enable
017	Line Feed	1 = Enable
018	Response Speed	0 = immediately
03-	Ethernet	
030	Ethernet Data Format	5 = Modbus RTU Lo-Hi
031	Ethernet Address	1
032	IP Address	192.168.016.250
033	Subnet Mask	255.255.255.000
034	Gateway Address	192.168.016.253
035	Local Port	502
036	Response Speed	0 = immediately
04-	Printer	
040	Print out format	2 = Multi line
041	CN	1 = Will be printed
042	Minimum print	20
043	Print method	0 = With Print Key
044	Line feed before printing	00 = 0 F + 0 LF
045	Line feed after printing	04 = 0 F + 2 LF
046	Form feed	0 = Disable
047	Space on the left	3
048	Quantity of copies	1
049	Date&Time	0 = Disable
05-	Profibus DP	
050	Data Format	0 = signed 32 bit
051	Rack Address	0
06-	Profinet, EtherNet/IP, EtherCAT	
060	Data Format	0 = signed 32 bit
07-	CANopen, CC-Link	
070	Data Format	0 = signed 32 bit
071	Rack Address	0
072	Baudrate	0 = 156 kbps
1--	Configuration Block	
11-	Start-Up	
116	Total indication	0 = Total-1
12-	Filter	
120	Filter	7

14-	Entries	
140	Date	
141	Time	
142	Label No entrance	
143	Display refresh rate	1 = 100ms
2--	Scale Block	
20-	Set up	
200	Approved	0 = No
201	Increased indication	0 = x10 key
203	Zero range	3 = ± %50
204	Auto zero tracking	0 = Disable
206	Motion detector	2 = ± 1e
21-	Scale Build	
212	Capacity / d	60 kg / 0.01 kg
214	Unit	0 = kg
3--	Calibration Block	
30-	Calibration	
301	Calibration	
302	Linearity Correction	
31-	Adjustment	
310	Zero adjustment	
311	Span adjustment	
312	Span adjustment under load	
313	eCal Calibration	
5--	Filling Block	
50-	Filling Parameters	
501	Feeding type	1
502	Preact correction factor	50%
504	Check delay	1.0 sec.
505	Zeroing period	250 sec.
506	Zeroing delay	2.0 sec.
507	Indication at the end of filling	0
508	Feeding check delay	100
509	Maximum filling weight	999999
8--	Metrological Data Block	
80-	Legal Metrology	
800	Calibration counter	
9--	Diagnostic	
90-	Tests	
900	Key Pad testing	
901	RS 232C testing	
902	RS 485 testing	
903	Parallel inputs test	
904	Parallel outputs test	
905	mV indication	
99-	Printing Parameters	
990	Whole parameters	
991	Load default parameters	

21. CALIBRATION TABLE

n = Max Capacity / e recommended values are given in the table below. You can use this table to select your Max and e values. Max value can be entered freely.

SCALE INTERVAL (e)		NUMBER OF SCALE INTERVAL (n)																		
		1000	2000	2400	2500	3000	4000	5000	6000	8000	10000	12000	15000	16000	20000	25000	30000	40000	50000	60000
0,001	1	2				3	4	5	6	8	10	12	15	16	20	25	30	40	50	60
0,002	2	4		5		6	8	10	12	16	20	24	30	32	40	50	60	80	100	120
0,005	5	10	12		15	20	25	30	40	50	60	80	75	80	100	125	150	200	250	300
0,01	10	20	24	25	30	40	50	60	80	100	120	150	160	200	250	300	400	500	600	800
0,02	20	40	48	50	60	80	100	120	160	200	240	300	320	400	500	600	800	1.000	1.200	1.200
0,05	50	100	120	125	150	200	250	300	400	500	600	750	800	1.000	1.250	1.500	2.000	2.500	3.000	3.000
0,1	100	200	240	250	300	400	500	600	800	1.000	1.200	1.500	1.600	2.000	2.500	3.000	4.000	5.000	6.000	6.000
0,2	200	400	480	500	600	800	1.000	1.200	1.600	2.000	2.400	3.000	3.200	4.000	5.000	6.000	8.000	10.000	12.000	12.000
0,5	500	1.000	1.200	1.250	1.500	2.000	2.500	3.000	4.000	5.000	6.000	7.500	8.000	10.000	12.500	15.000	20.000	25.000	30.000	30.000
1	1.000	2.000	2.400	2.500	3.000	4.000	5.000	6.000	8.000	10.000	12.000	15.000	16.000	20.000	25.000	30.000	40.000	50.000	60.000	60.000
2	2.000	4.000	4.800	5.000	6.000	8.000	10.000	12.000	16.000	20.000	24.000	30.000	32.000	40.000	50.000	60.000	80.000	100.000	120.000	120.000
5	5.000	10.000	12.000	12.500	15.000	20.000	25.000	30.000	40.000	50.000	60.000	75.000	80.000	100.000	125.000	150.000	200.000	250.000	300.000	300.000
10	10.000	20.000	24.000	25.000	30.000	40.000	50.000	60.000	80.000	100.000	120.000	150.000	160.000	200.000	250.000	300.000	400.000	500.000	600.000	600.000
20	20.000	40.000	48.000	50.000	60.000	80.000	100.000	120.000	160.000	200.000	240.000	300.000	320.000	400.000	500.000	600.000	800.000			
50	50.000	80.000	120.000	125.000	150.000	200.000	250.000	300.000	400.000	500.000	600.000	750.000	800.000							
100	100.000	200.000	240.000	250.000	300.000	400.000	500.000	600.000	800.000											
200	200.000	400.000	480.000	500.000	600.000	800.000														

22. FREQUENTLY ASKED QUESTIONS

Question	: My PC could not interface with BX14. How can I check the com port?
Answer	: – Connect the instrument to the PC and run Hyper Terminal. – Check com ports as described in The Diagnostic Test section on <i>Page 60</i> .
Question	: IndFace1X installation needs restart every time. How can I install it?
Answer	: – Read and follow the installation notes in the installation directory. – Update your computer (visit http://update.microsoft.com).
Question	: IndFace1X could not connect to instrument. What can I do?
Answer	: – Check the power, data cabling and LED status of the BX14 instrument. – Check PC port setting. – Remove other connections. Re-energize the BX14 instrument and then make connection.
Question	: My PC doesn't have any COM port. How can I connect instrument to my PC?
Answer	: You can use RS-232 / USB converter for serial interfacing via USB port. And select com port with Connection Settings menu.
Question	: My PC have a COM port but I couldn't see COM port in Connection Setting menu. How can I solve that problem?
Answer	: Another software may be connected to that COM port. Close all applications before running IndFace1X.
Question	: My PC could not interface with BX14. How can I check the com ports?
Answer	: Short circuit your com port RXD and TXD pins. Check if the sending data is received or not by using any terminal software. You may test also BX14 com ports as described in The Diagnostic Tests section on <i>Page 60</i> by short circuiting RXD and TXD terminals.
Question	: I need very fast interfacing. What is the response delay time of BX14?
Answer	: BX14 response delay is max. 4 milliseconds for weight data. Extremely fast interfacing.
Question	: What is the external conversion rate of BX14?
Answer	: Only fast continuous data output rate might be called as an external conversion rate which is depend on the baud rate and data length and up to 85 conversion/second.
Question	: How can I check Ethernet connection?
Answer	: – BX14 EN has a dummy web page. You can easily open web page with any browser installed on any PC in network.
Question	: EtherX is searching but it could not find any instrument over Local Network Area.
Answer	: – Check the Exceptions tap in Windows firewall settings. EtherX should be marked. – Check the firewall of Anti-virus program, If you have.
Question	: I done crossover connection with BX14 EN but EtherX could not find it.
Answer	: – Check the Internet Protocol (TCP/IP) Properties in Local Area Connection of Windows. IP address blocks and gateway address of BX14 and PC should be the same in cross connection.

NOTES:

BAYKON

Industrial Weighing Systems



Kimya Sanayicileri Organize Sanayi Bölgesi Organik Cad. No:31
Tepeören, 34956 İstanbul, TURKEY

Tel : +90 216 593 26 30 (pbx) Fax : +90 216 593 26 38

e-mail: servis@baykon.com

[http:// www.baykon.com](http://www.baykon.com)